

MADE IN ITALY. MADE TO EXCEL.

MARVEL

TRAVERTINE

Interactive version



 atlas concorde

September 2022

MARBLE LOOK

PORCELAIN TILES
GRES PORCELLANATO
Grès cérame
Feinsteinzeug
Gres porcelánico
Керамический гранит



Atlas Concorde is one of the leading global brands in the production of ceramic tiles and large slabs for design and architecture. With over 50 years of history, two production plants, and numerous showrooms in the capitals of international design, Atlas Concorde offers integrated and sustainable ceramic systems for floors, walls, outdoor spaces, worktops, bathroom furnishings, facades and special projects. Design your world with Atlas Concorde.

Atlas Concorde è uno dei principali brand mondiali nella produzione di superfici e grandi lastre ceramiche per il design e l'architettura. Con oltre cinquant'anni di storia, due stabilimenti produttivi, numerose showroom nelle capitali della progettazione internazionale, offriamo sistemi ceramici integrati e sostenibili per pavimenti, rivestimenti, outdoor, piani di lavoro, arredo bagno, facciate e progetti speciali. Design your world with Atlas Concorde.

atlasconcorde.com



INDEX



ENJOY
THE VIDEO



EN | IT | FR | DE | RU

OVERVIEW



HBA
HIRSCH
BEDNER
ASSOCIATES



IMAGE
GALLERY



SURFACE
RANGE &
TECHNICAL
SPECS.



MARVEL WORLD



WE CARE



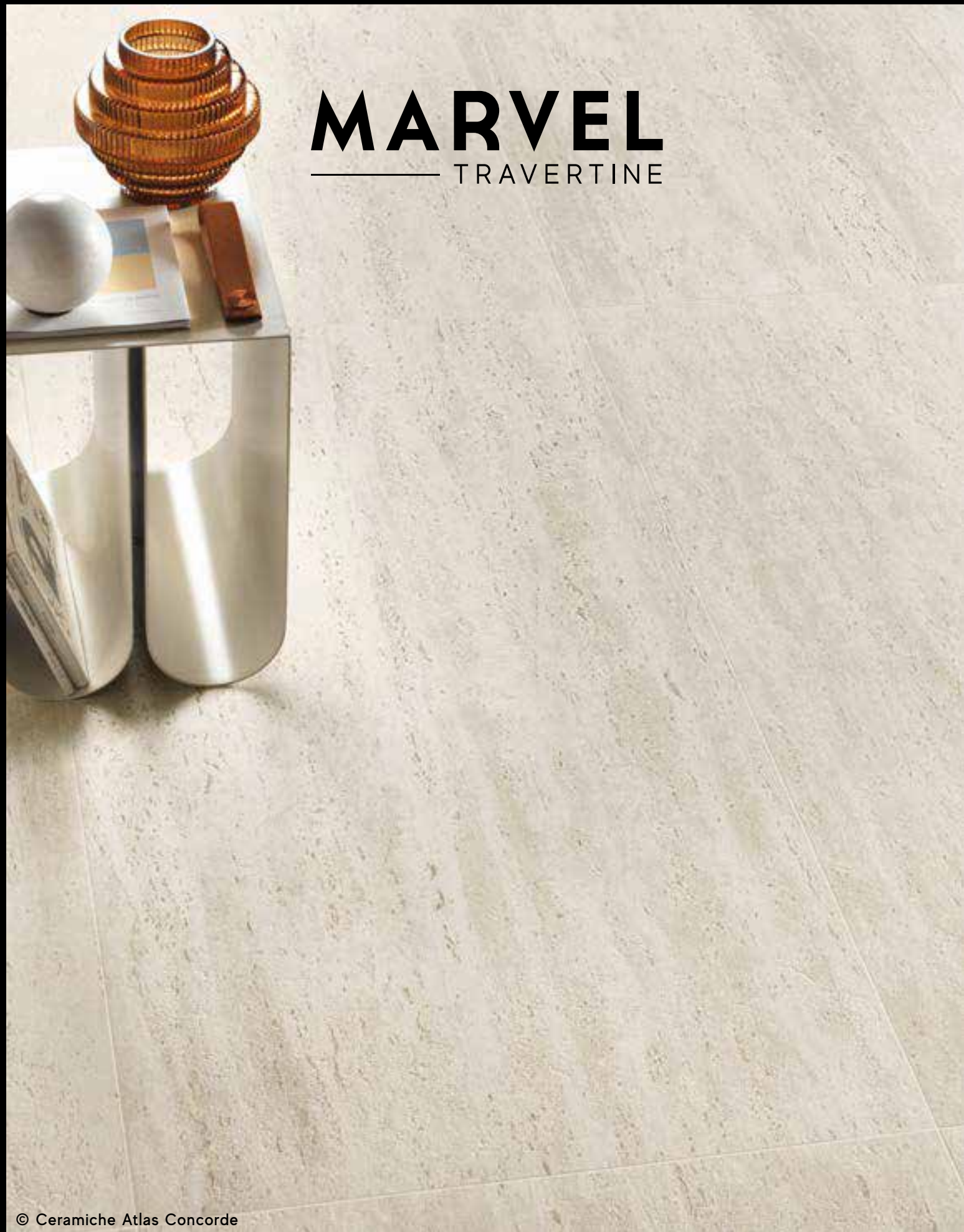

MARVEL
TRAVERTINE

Enjoy the video

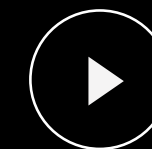

EN | IT | FR | DE | RU

Overview



Collaboration

Image Gallery

Surface Range &
Technical Specs

SENSITECH TECHNOLOGY
COLLECTION RANGE
TECHNICAL SPECIFICATIONS

Marvel World

We Care

PORCELAIN TILES: A SAFE CHOICE
ENVIRONMENTAL SUSTAINABILITY
ETHICAL IDENTITY

ENJOY THE VIDEO



EN | IT | FR | DE | RU

OVERVIEW



HBA
HIRSCH
BEDNER
ASSOCIATES



IMAGE
GALLERY



SURFACE
RANGE &
TECHNICAL
SPECS.



MARVEL WORLD



WE CARE



© Ceramiche Atlas Concorde

HERITAGE FOR THE FUTURE

MARVEL
10 YEARS
2012 — 2022

ENJOY
THE VIDEO
EN | IT | FR | DE | RU

Over the course of ten years the Marvel world has become a benchmark for international design. Marvel Travertine celebrates its international architectural vocation, thanks to the partnership with the prestigious firm of Hirsch Bedner Associates, specialized in hospitality design.

In dieci anni, il mondo Marvel è diventato un punto di riferimento per il design internazionale. Marvel Travertine ne celebra la vocazione architettonica internazionale, grazie alla partnership con il prestigioso studio Hirsch Bedner Associates, specializzato nell'hospitality design.

En dix ans, l'univers Marvel est devenu une référence en matière de design international. Marvel Travertine célèbre sa vocation architecturale internationale, grâce à son partenariat avec le prestigieux cabinet Hirsch Bedner Associates, spécialisé dans le design d'hospitalité.

In zehn Jahren hat sich die Marvel-Welt zu einem Bezugspunkt für internationales Design entwickelt. Seine internationale architektonische Berufung feiert Marvel Travertine durch die Partnerschaft mit dem renommierten Studio Hirsch Bedner Associates, das sich auf das Hospitality Design spezialisiert hat.

En diez años, el mundo Marvel se ha convertido en un referente del diseño internacional. Marvel Travertine celebra su vocación arquitectónica internacional, gracias a la asociación con el prestigioso estudio Hirsch Bedner Associates, especializado en diseño de hostelería.

За десять лет проект Marvel стал эталонным для мира международного дизайна. По случаю юбилея он пополнился новой коллекцией Marvel Travertine – плодом сотрудничества с известной архитектурной студией Hirsch Bedner Associates, специализирующейся на дизайне интерьеров для индустрии гостеприимства.

INDEX



ENJOY
THE VIDEO



EN | IT | FR | DE | RU

OVERVIEW



HBA
HIRSCH
BEDNER
ASSOCIATES



IMAGE
GALLERY



SURFACE
RANGE &
TECHNICAL
SPECS.



MARVEL WORLD



WE CARE



Eternal material.



The majesty of travertine, an iconic architectural material that symbolizes power and stability, lives again in Marvel Travertine's ceramic surfaces.

La maestosità del travertino, materiale iconico dell'architettura simbolo di potere e stabilità, rivive sulle superfici ceramiche di Marvel Travertine come un moderno protagonista della scena.

La majesté du travertin, matériau architectural iconique symbolisant le pouvoir et la stabilité, revit sur les surfaces en céramique de Marvel Travertine comme un protagoniste moderne de la scène.

Die Majestät des Travertins, eines ikonischen architektonischen Materials, das Macht und Stabilität symbolisiert, lebt auf den Keramikoberflächen von Marvel Travertine als moderner Protagonist der Szene wieder auf.

La majestuosidad del travertino, un material icónico de la arquitectura que simboliza el poder y la estabilidad, vuelve a vivir en las superficies cerámicas de Marvel Travertine como protagonista moderno de la escena.

Величественность травертина, культового архитектурного материала, символа силы и стабильности, вновь оживает на керамических плитках Marvel Travertine.

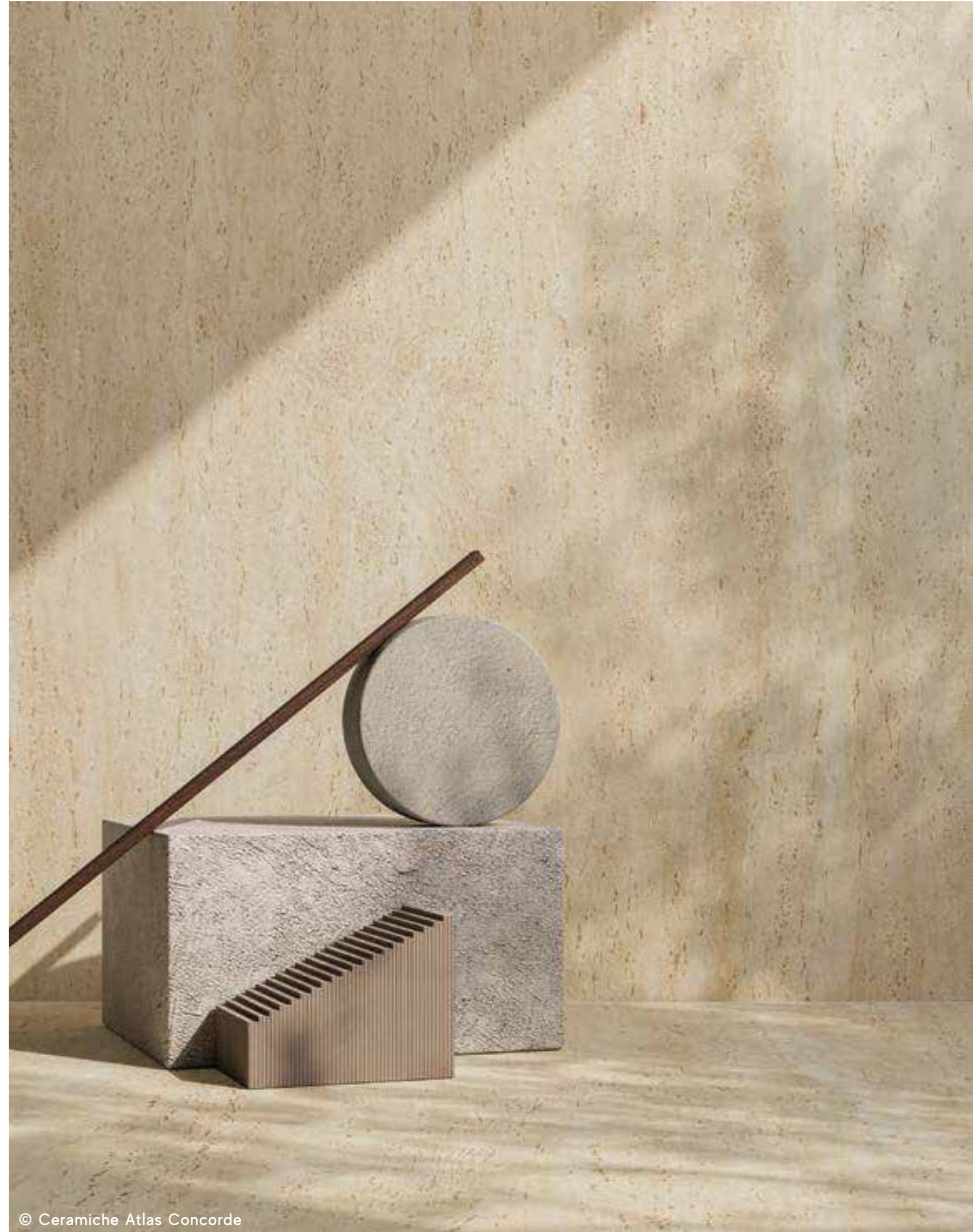

© Ceramiche Atlas Concorde

INDEX



ENJOY THE VIDEO



EN | IT | FR | DE | RU

OVERVIEW



HBA HIRSCH BEDNER ASSOCIATES



IMAGE GALLERY



SURFACE RANGE & TECHNICAL SPECS.



MARVEL WORLD



WE CARE





© Ceramiche Atlas Concorde

Ceramic perfection, natural realism.



© Ceramiche Atlas Concorde



© Ceramiche Atlas Concorde

Soft-touch ceramic surfaces that faithfully reproduce natural stone. Three warm shades with soft hues and the refined realism of the pores typical of travertine represent the strength of this collection.

Superfici ceramiche dalla mano morbida che riproducono fedelmente la pietra naturale. Tre tonalità calde dalle sfumature morbide e una ricercata realistica dei tipici pori del travertino rappresentano la forza di questa collezione.

Des surfaces céramiques à la main douce qui reproduisent fidèlement la pierre naturelle. Trois teintes chaudes aux nuances douces et un réalisme raffiné des pores typiques du travertin représentent la force de cette collection.

Keramikoberflächen mit weichem Handgefühl, die dem Naturstein nachempfunden sind. Drei warme Farbtöne mit sanften Nuancen und der raffinierte Realismus der typischen Poren des Travertins sind die Stärke dieser Kollektion.

Superficies cerámicas suaves al tacto que reproducen fielmente la piedra natural. Tres tonos cálidos con matices suaves y el refinado realismo de los poros típicos del travertino representan la fuerza de esta colección.

Мягкая на ощупь поверхность плитки точно-в-точь воспроизводит рисунок природного камня. Сила коллекции – в трех теплых цветах с деликатными оттенками и в изысканном реализме фактуры с характерными для травертина порами.

INDEX



ENJOY THE VIDEO



EN | IT | FR | DE | RU

OVERVIEW



HBA HIRSCH BEDNER ASSOCIATES



IMAGE GALLERY



SURFACE RANGE & TECHNICAL SPECS.



MARVEL WORLD



WE CARE



Contemporary colors and surfaces.

Considered a peer of the finest marbles, travertine is actually a stone. This dual marble-stone identity is expressed in Marvel Travertine in the two variants of Vein Cut and Cross Cut. The Vein Cut reproduces the striped appearance typical of travertine, while the Cross Cut shows off its rich colors with a stone-look surface characterized by extensive shading.

Ricordato al pari dei marmi più pregiati, il travertino è in realtà una pietra. Questa duplice identità marmo-pietra si esprime in Marvel Travertine nelle due varianti Vein Cut e Cross Cut. Il taglio Vein Cut riproduce il tipico aspetto striato del travertino, mentre il taglio Cross Cut ne valorizza la ricchezza cromatica con una superficie dall'aspetto pietra caratterizzata da sfumature estese.

Reconnu au même titre que les plus beaux marbres, le travertin est en fait une pierre. Cette double identité de la pierre marbrière est exprimée dans le Marvel Travertine dans les deux variantes Vein Cut et Cross Cut. La coupe Vein Cut reproduit l'aspect strié typique du travertin, tandis que la coupe Cross Cut renforce sa richesse chromatique avec une surface d'aspect pierreux caractérisée par des ombres étendues.

Travertin ist ein Stein, der den feinsten Marmorarten in nichts nachsteht. Diese doppelte Identität Marmor/Stein kommt in Marvel Travertine in den beiden Varianten Vein Cut und Cross Cut zum Ausdruck. Der Schliff Vein Cut bringt das typische gestreifte Erscheinungsbild von Travertin hervor, während der Schliff Cross Cut den Farbreichtum mit einer steinähnlichen Oberfläche, die sich durch starke Schattierungen auszeichnet, hervorhebt.

El travertino goza del mismo reconocimiento que los mármoles más finos, pero en realidad es una piedra. Esta piedra de mármol de doble identidad se expresa en Marvel Travertine en las dos variantes Vein Cut y Cross Cut. El corte Vein Cut reproduce el típico aspecto estriado del travertino, mientras que el corte Cross Cut realza su riqueza cromática con una superficie de aspecto piedra caracterizada por un amplio sombreado.

Травертин напоминает мрамор, но на самом деле является камнем. Эта двойная натура, мрамора и камня, отражается в Marvel Travertine в двух вариантах рисунка распила: Vein Cut и Cross Cut. Распил Vein Cut передает характерный полосатый облик травертина, а Cross Cut имеет богатую пятнистую окраску с обширными оттенками.



© Ceramiche Atlas Concorde

[INDEX](#)

[ENJOY THE VIDEO](#)

[EN | IT | FR | DE | RU](#)
[OVERVIEW](#)

[HBA
HIRSCH
BEDNER
ASSOCIATES](#)

[IMAGE GALLERY](#)

[SURFACE RANGE & TECHNICAL SPECS.](#)

[MARVEL WORLD](#)

[WE CARE](#)

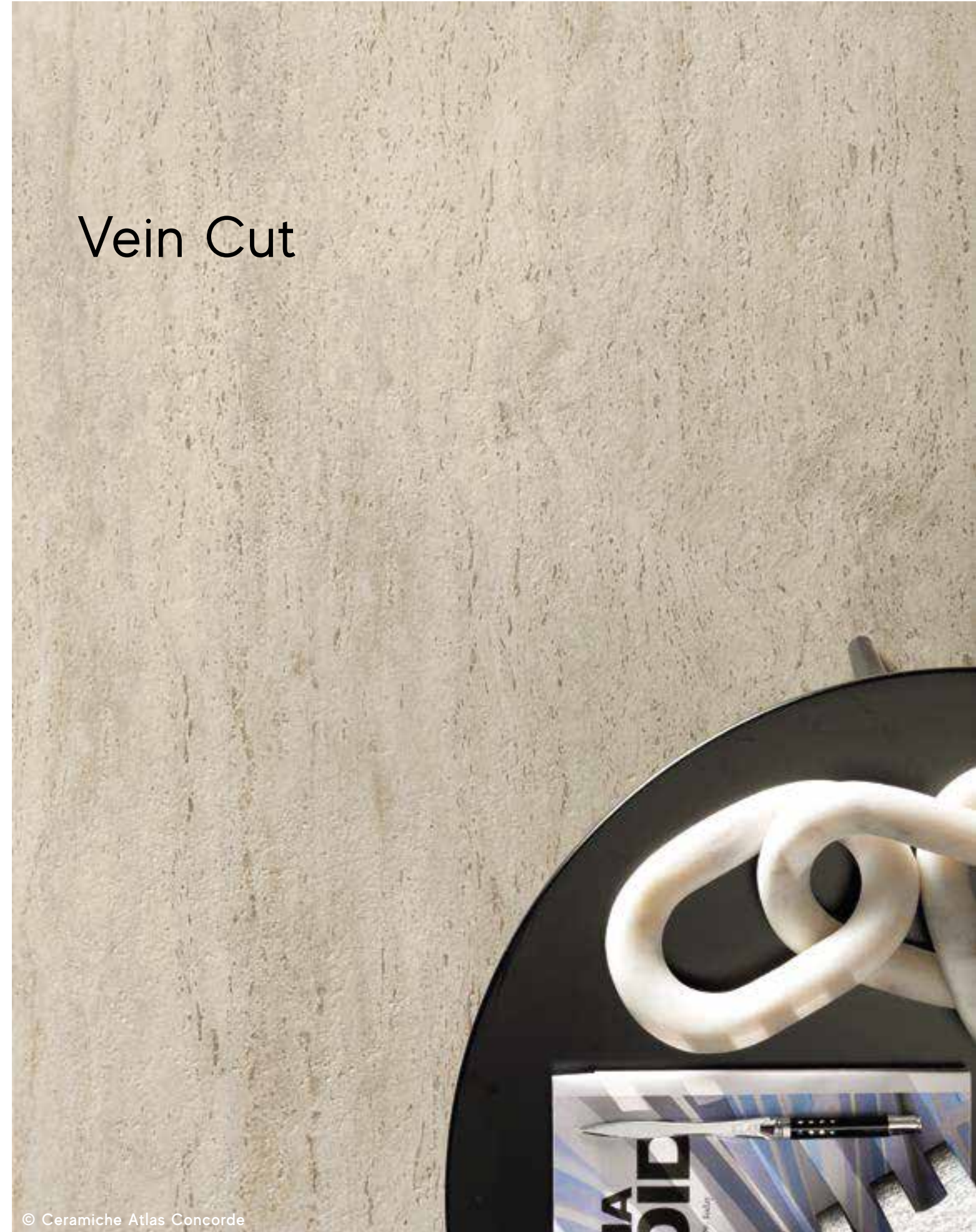
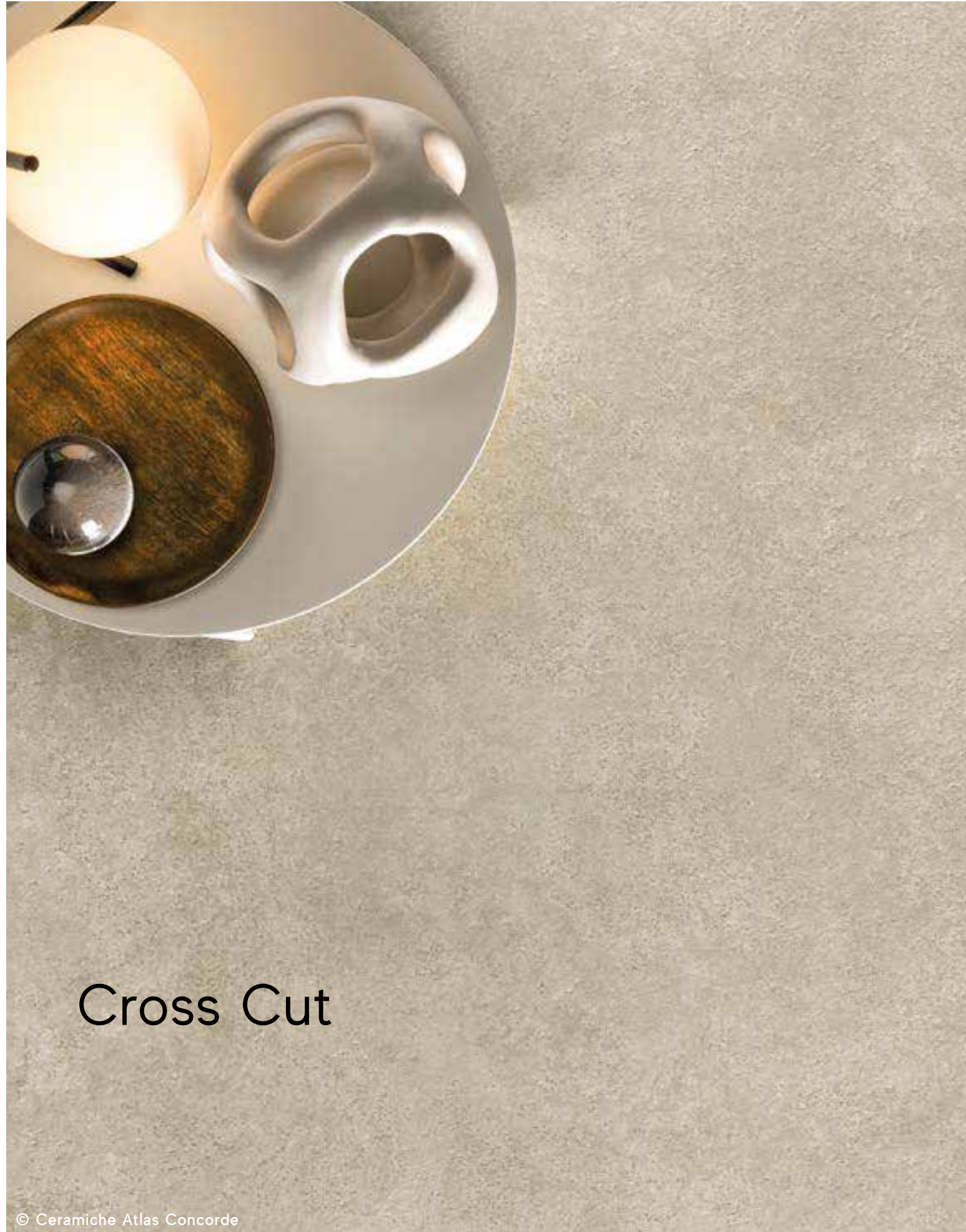
INDEX



ENJOY THE VIDEO



EN | IT | FR | DE | RU

OVERVIEW



HBA
HIRSCH
BEDNER
ASSOCIATES



IMAGE
GALLERY



SURFACE
RANGE &
TECHNICAL
SPECS.



MARVEL WORLD



WE CARE



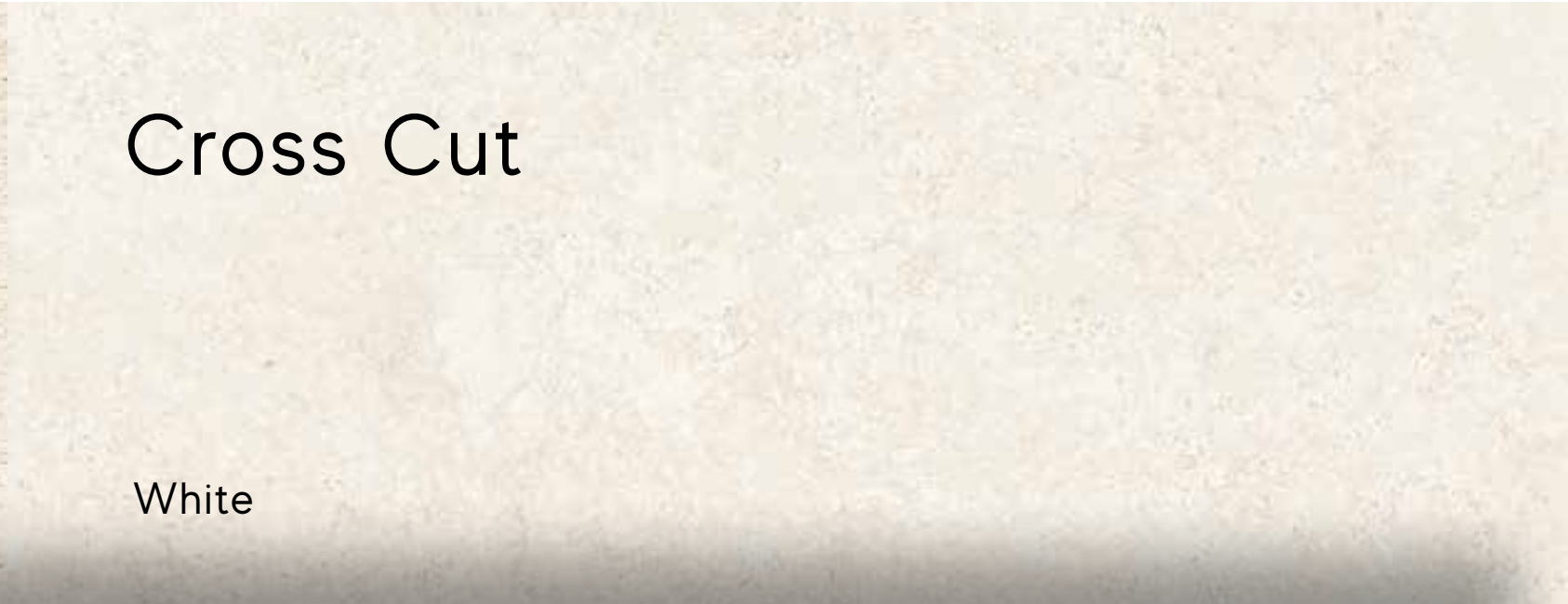

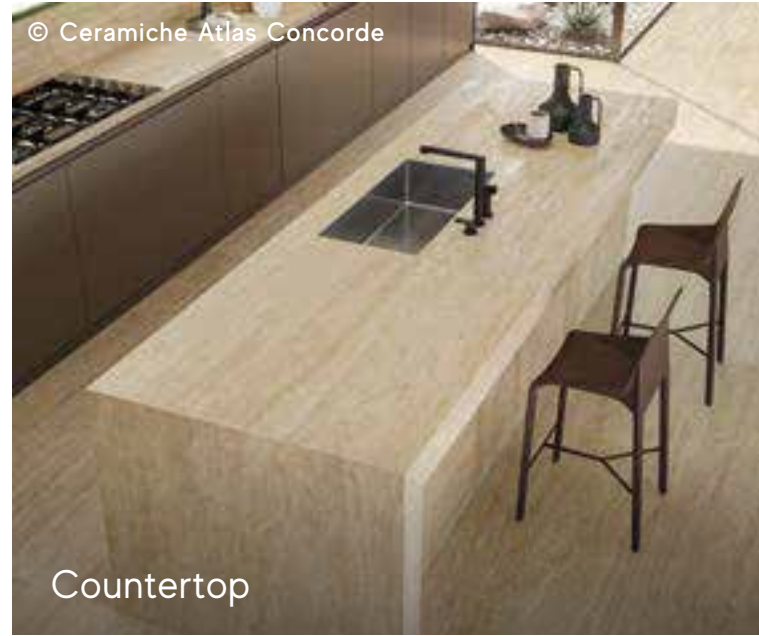

Complete product system.

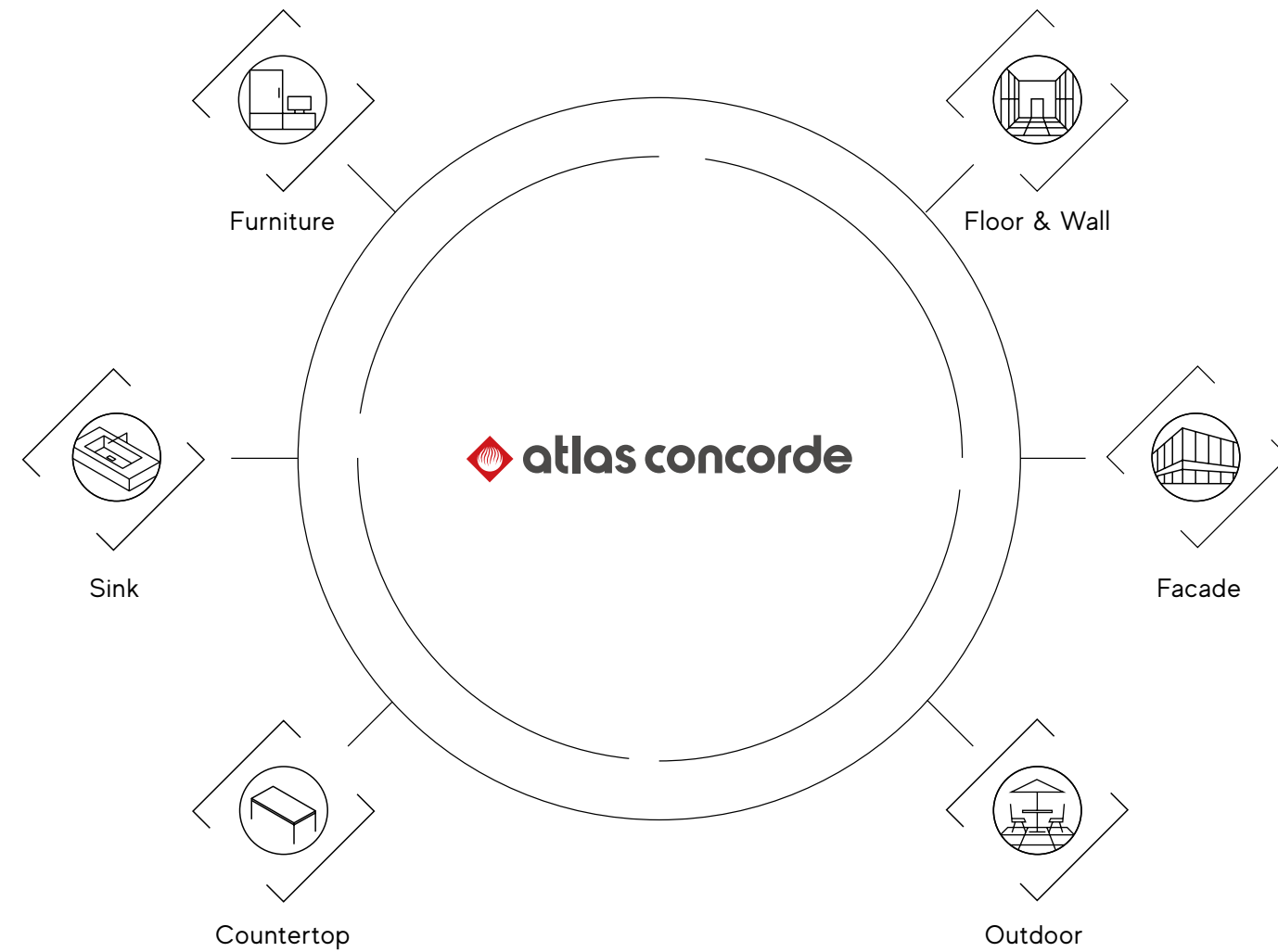

Marvel Travertine is a complete system of surfaces that allows you to reproduce the look of travertine on indoor and outdoor floors, walls and facades, kitchen countertops, tables, and washbasins.

Marvel Travertine è un sistema completo di superfici che permette di estendere l'aspetto del travertino a pavimenti interni ed esterni, rivestimenti di pareti e di facciate, piani cucina, tavoli e lavabi.

Marvel Travertine est un système de surface complet qui permet d'étendre l'apparence du travertine aux sols intérieurs et extérieurs, aux revêtements de murs et de façades, aux comptoirs de cuisine, aux tables et aux lavabos.

Marvel Travertine ist ein komplettes Oberflächensystem, mit dem das Erscheinungsbild von Travertin auf Böden im Innen- und Außenbereich, Wand- und Fassadenverkleidungen, Küchenarbeitsplatten, Tische und Waschbecken ausgedehnt werden kann.

Marvel Travertine es un sistema completo de superficies que permite extender el aspecto del travertino a pavimentos interiores y exteriores, revestimientos de paredes y fachadas, encimeras de cocina, mesas y lavabos.

Marvel Travertine – это комплексная система плитки, которая позволяет перенести рисунок травертина на полы внутри помещений и на улице, на стены и фасады, на столешницы кухонных гарнитуров и столов, на умывальники.

Sensitech

SAFE. SOFT. SMART.

Research and technological innovation have led to the development of Sensitech, a surface achieved with a technology patented in Italy that combines a high anti-slip coefficient with a pleasant touch. Safety and ease of cleaning are the characteristics of Sensitech surface.

Ricerca e innovazione tecnologica hanno prodotto Sensitech, una superficie ottenuta con una tecnologia brevettata in Italia che coniuga un elevato coefficiente anti-scivolo con una sensazione tattile piacevole. Sicurezza e facilità di pulizia sono le caratteristiche delle superfici Sensitech.

La recherche et l'innovation technologique ont donné naissance à Sensitech, une surface réalisée à l'aide d'une technologie italienne brevetée qui associe un coefficient antidérapant élevé à une agréable sensation tactile. Sécurité et facilité de nettoyage sont les caractéristiques des surfaces Sensitech.

Forschung und technologische Innovation haben Sensitech hervorgebracht – eine Oberfläche, die mit einer in Italien patentierten Technologie hergestellt wird, die einen hohen Rutschfestigkeitskoeffizienten mit einer angenehmen Haptik verbindet. Sicherheit, leichte Reinigung und eine „Barrierewirkung“ gegen Schmutz sind die Merkmale der Sensitech-Oberflächen.

La investigación y la innovación tecnológica han dado lugar a Sensitech, una superficie realizada con una tecnología patentada en Italia que combina un alto coeficiente antideslizante con una agradable sensación al tacto. Seguridad, facilidad de limpieza son las características de las superficies Sensitech.

В результате кропотливых исследований и технологических инноваций появилась поверхность Sensitech – нескользкая и удивительно приятная на ощупь. Технология ее изготовления запатентована в Италии. Особенности поверхности Sensitech являются безопасностью и простота в уходе.



© Ceramiche Atlas Concorde



page 116

INDEX



ENJOY THE VIDEO



EN | IT | FR | DE | RU

OVERVIEW



HBA HIRSCH BEDNER ASSOCIATES



IMAGE GALLERY



SURFACE RANGE & TECHNICAL SPECS.



MARVEL WORLD



WE CARE





HBA and Atlas Concorde, the global alliance for architecture and interior design.



Inspired by the ancient link between travertine and architecture, Atlas Concorde has established a partnership with the renowned interior design firm Hirsch Bedner Associates (HBA).

Ispirata dall'antico legame tra travertino e architettura, Atlas Concorde inaugura la collaborazione con il rinomato studio di interior design e progettazione Hirsch Bedner Associate, HBA.

Inspiré par l'ancien lien entre le travertin et l'architecture, Atlas Concorde inaugure une collaboration avec le célèbre cabinet d'architecture intérieure et de planification Hirsch Bedner Associate, HBA.

Inspiriert durch die uralte Verbindung zwischen Travertin und Architektur, leitet Atlas Concorde seine Partnerschaft mit dem renommierten Innenarchitektur- und Planungsbüro Hirsch Bedner Associate, HBA in die Wege.

Inspirado en el antiguo vínculo entre el travertino y la arquitectura, Atlas Concorde inaugura una colaboración con la renombrada firma de diseño de interiores y ingeniería Hirsch Bedner Associate, HBA.

Вдохновленная древней связью между травертином и архитектурой, компания Atlas Concorde начала сотрудничество с известной студией дизайна Hirsch Bedner Associate, HBA.



The world's leading hospitality design firm.



HBA LOCATIONS

- Atlanta
- Bali
- Bangkok
- Beijing
- Clark
- Dubai
- Guangzhou
- Ho Chi Minh
- Hong Kong
- Istanbul
- Jakarta
- London
- Los Angeles
- Manila
- Miami
- Mumbai
- New Delhi
- Riyadh
- San Francisco
- Seoul
- Shanghai
- Shenzhen
- Singapore
- Tokyo

“We were very impressed by the beauty of Marvel Travertine. So it was easy to discover that we and Atlas Concorde share the same passion for design and excellence.”



Ian Carr
CEO



Paula O'Callaghan
PARTNER

“As designers, we have the responsibility to create spaces respecting the environment and people. Atlas Concorde surfaces allow us to be consistent with this mission.”

Leading the hotel design industry since 1965, HBA creates signature looks for today's luxury brands and unveils the world's most anticipated hotels, resorts, spas, casinos, restaurants, cruise ships, independent contemporary boutique hotels and world-class residences. HBA has 24 offices worldwide, over 1,500 completed projects in over 80 countries, and more than 200 global design awards won in the past decade.

Leader dans le domaine de la conception d'hôtels et resorts depuis 1965, HBA crée des looks uniques pour les marques de luxe d'aujourd'hui. Elle réalise actuellement des hôtels spectaculaires, des resorts, des spas, des casinos, des restaurants, des navires de croisière, des hôtels-boutiques indépendants et contemporains ainsi que des résidences de haut standing et de renommée internationale. HBA compte 24 sièges dans le monde, a réalisé plus de 1.500 projets dans plus de 80 pays et a remporté plus de 200 prix de design dans le monde au cours des dix dernières années.

Líder en el diseño de hoteles y resorts desde 1965, HBA crea estilos de autor para las marcas de lujo de hoy. Actualmente crea espectaculares hoteles, resorts, spas, casinos, restaurantes, cruceros y hoteles boutique independientes y contemporáneos, así como también residencias de alta categoría y de primer nivel en todo el mundo. HBA tiene 24 oficinas a nivel global, más de 1.500 proyectos realizados en más de 80 países y ha ganado más de 200 premios de diseño en todo el mundo en los últimos diez años.

Leader nel settore della progettazione di hotel e resort dal 1965, HBA crea look d'autore per i marchi di lusso di oggi. Realizza attualmente spettacolari hotel, resort, spa, casinò, ristoranti, navi da crociera, boutique-hotel indipendenti e contemporanei, nonché residenze di alta classe e di fama mondiale. HBA ha 24 sedi a livello globale, oltre 1.500 progetti completati in più di 80 Paesi e ha vinto più di 200 premi di design nel mondo negli ultimi dieci anni.

HBA ist seit 1965 führend im Bereich Hotel- und Resortdesign und entwirft unverwechselbare Designs für die Luxusmarken von heute. Derzeit werden spektakuläre Hotels, Resorts, Spas, Casinos, Restaurants, Kreuzfahrtschiffe, unabhängige und moderne Boutique-Hotels sowie erstklassige und weltbekannte Residenzen gebaut. HBA hat 24 Standorte weltweit, über 1.500 abgeschlossene Projekte in mehr als 80 Ländern und hat in den letzten zehn Jahren weltweit mehr als 200 Designpreise gewonnen.

Студия HBA является лидером в проектировании отелей с 1965 года и сегодня разрабатывает престижные авторские проекты для самых элитных брендов. В ее портфолио всемирно известные отели, курортные комплексы, спа, казино, рестораны, круизные лайнеры, бутик-отели, а также частные дома. Имеет 24 офиса в разных частях света, реализовала более 1.500 проектов в более чем 80 странах мира и за последнее десятилетие получила более 200 международных наград в области дизайна.

Exclusive and unique decors.



HBA and Atlas Concorde teams at work in Atlas Concorde's Showroom

Marvel Travertine's surfaces find a perfect fit in the sophisticated hospitality settings designed by HBA, which also designed the collection's exclusive range of decors.

Les surfaces de Marvel Travertine s'intègrent parfaitement dans les environnements hospitality sophistiqués conçus par HBA, qui conçoit également la gamme décorative exclusive de la collection.

Las superficies de Marvel Travertine encajan perfectamente en los sofisticados contextos de hospitality diseñados por HBA, que también diseña la exclusiva gama decorativa de la colección.

Le superfici di Marvel Travertine trovano una perfetta collocazione nei contesti hospitality dal taglio ricercato firmati HBA, che ha disegnato anche l'esclusiva gamma decorativa della collezione.

Die Oberflächen von Marvel Travertine fügen sich perfekt in die von HBA entworfenen, anspruchsvollen Hospitality-Kontexte ein. HBA gestaltet auch die exklusive Dekorationspalette der Kollektion.

Плитка Marvel Travertine идеально вписывается в изысканные проекты гостиниц от студии HBA, которая, помимо всего прочего, разработала и эксклюзивную гамму декоративных элементов коллекции.



© Ceramiche Atlas Concorde



© Ceramiche Atlas Concorde



© Ceramiche Atlas Concorde



© Ceramiche Atlas Concorde



© Ceramiche Atlas Concorde

INDEX



ENJOY THE VIDEO



EN | IT | FR | DE | RU

OVERVIEW



HBA HIRSCH BEDNER ASSOCIATES



IMAGE GALLERY



SURFACE RANGE & TECHNICAL SPECS.



MARVEL WORLD



WE CARE





Marvel Travertine in HBA projects.

THE HOSPITALITY DESIGN CONCEPT

“We choose Marvel Travertine for its outstanding contemporary style and extreme realism, perfect for hospitality design and much more.”



Lesha Fernando
ASSOCIATE



THE HOSPITALITY DESIGN CONCEPT

ENJOY THE VIDEO



EN | IT | FR | DE | RU

OVERVIEW



HBA
HIRSCH
BEDNER
ASSOCIATES



IMAGE
GALLERY



SURFACE
RANGE &
TECHNICAL
SPECS.



MARVEL WORLD



WE CARE



© Ceramiche Atlas Concorde

LOBBY



FLOOR
Marvel Travertine
Pearl
Mosaico Basketweave
35x46,8 cm | 13³/₈"x18¹/₂"

Marvel Gala
Calacatta Black
120x120 cm | 47¹/₄"x47¹/₄"

WALL
Marvel Travertine
Pearl Vein Cut
120x278 cm | 47¹/₄"x109¹/₂"

Marvel Gala
Amazonite
120x278 cm | 47¹/₄"x109¹/₂"



© Ceramiche Atlas Concorde

BATHROOM



FLOOR
Marvel Gala
Calacatta Black
120x120 cm | 47¹/₄"x47¹/₄"

WALL
Marvel Travertine
Pearl Vein Cut
120x278 cm | 47¹/₄"x109¹/₂"

Marvel Gala
Calacatta Black
120x278 cm | 47¹/₄"x109¹/₂"



© Ceramiche Atlas Concorde

SPA



FLOOR
Marvel Travertine
Pearl Vein Cut
120x240 cm | 47¹/₄"x94¹/₂"

WALL
Marvel Travertine
Pearl Vein Cut
120x278 cm | 47¹/₄"x109¹/₂"

Marvel Travertine
Pearl
Diamond
60x60 cm | 23³/₈"x23³/₈"



THE HOSPITALITY DESIGN CONCEPT

ENJOY THE VIDEO



EN | IT | FR | DE | RU

OVERVIEW



HBA
HIRSCH
BEDNER
ASSOCIATES



IMAGE
GALLERY



SURFACE
RANGE &
TECHNICAL
SPECS.



MARVEL WORLD



WE CARE



© Ceramiche Atlas Concorde

DINING ROOM



FLOOR
Marvel Travertine
Pearl Vein Cut
120x240 cm | 47 1/4" x 94 1/2"
WALL
Marvel Travertine
Pearl
Mosaico Origami
28x41,2 cm | 11" x 16 1/8"



© Ceramiche Atlas Concorde

SUITE



FLOOR
Marvel Travertine
Sand Vein Cut
120x240 cm | 47 1/4" x 94 1/2"
WALL
Marvel Travertine
Sand Vein Cut
120x278 cm | 47 1/4" x 109 1/2"
Marvel X
Calacatta Apuano
120x278 cm | 47 1/4" x 109 1/2"



© Ceramiche Atlas Concorde

LOBBY



FLOOR
Marvel Travertine
Sand Vein Cut
120x240 cm | 47 1/4" x 94 1/2"
WALL
Marvel Travertine
Sand Vein Cut
120x240 cm | 47 1/4" x 94 1/2"
Marvel Travertine
Sand
Mosaico Origami
28x41,2 cm | 11" x 16 1/8"



THE HOSPITALITY DESIGN CONCEPT

INDEX



ENJOY THE VIDEO



EN | IT | FR | DE | RU

OVERVIEW



HBA
HIRSCH
BEDNER
ASSOCIATES



IMAGE
GALLERY



SURFACE
RANGE &
TECHNICAL
SPECS.



MARVEL WORLD



WE CARE



© Ceramiche Atlas Concorde

FOOD & BEVERAGE



FLOOR
Marvel Travertine
Sand and White
Vein Cut

Marvel Edge
Gris Supreme
120x120 cm | 47 1/8" x 47 1/8"

WALL
Marvel Travertine
White
Mosaico Tessellation
22x31.6 cm | 8 5/8" x 12 3/8"



© Ceramiche Atlas Concorde

POOL



FLOOR
Marvel Travertine
White Cross Cut Grip
60x120 cm | 23 5/8" x 47 1/8"

WALL
Marvel Travertine
White Cross Cut
60x120 cm | 23 5/8" x 47 1/8"

Marvel Travertine
White
Chiselled Urban Grid
30x60 cm | 11 7/8" x 23 5/8"

Marvel Travertine
White
Mosaico Basketweave
35x46.8 cm | 13 3/8" x 18 1/2"



© Ceramiche Atlas Concorde

BATHROOM



FLOOR
Marvel Travertine
Sand Cross Cut
120x120 cm | 47 1/8" x 47 1/8"

WALL
Marvel Travertine
Sand
Chiselled Urban Grid
30x60 cm | 11 7/8" x 23 5/8"

Marvel X
Calacatta Apuano
120x278 cm | 47 1/8" x 109 1/2"





Exclusive selection of decors.



THE DECOR DESIGN CONCEPT

“Decors are a great tool in a project. That’s why we decided to create a unique range of decors for international design. Patterns, wall and floor decorations immediately draw the attention on a particular area. They help partition different spaces and, most importantly, they add character to interiors.”



Lesha Fernando
ASSOCIATE

INDEX



ENJOY THE VIDEO



EN | IT | FR | DE | RU

OVERVIEW



HBA
HIRSCH
BEDNER
ASSOCIATES



IMAGE GALLERY



SURFACE RANGE & TECHNICAL SPECS.



MARVEL WORLD



WE CARE





© Ceramic Atlas Concorde



© Ceramic Atlas Concorde

Diamond

Designed by **HBA**

Surface furrowed by ray geometries and enriched by inclusions of precious metals.

Surface sillonnée par des géométries rayonnantes et enrichie d'inclusions de métaux précieux.

Una superficie surcada por geometrías radiantes y enriquecida con inclusiones de metales preciosos.

Superficie solcata da geometrie a raggiera e arricchita da inclusioni di metalli preziosi.

Die Oberflächen sind von strahlenförmigen Geometrien durchzogen und mit Einschlüssen von Edelmetallen angereichert.

Поверхность изрисована радиальными штрихами и обогащена включениями драгоценных металлов.



© Ceramiche Atlas Concorde



© Ceramiche Atlas Concorde

Tessellation

Designed by
HBA

Composition of triangular and square tiles of perfect proportions alternate Vein Cut and Cross Cut elements.

Des compositions de carreaux triangulaires et carrés parfaitement proportionnés alternent les éléments Vein Cut et Cross Cut.

Composición de baldosas triangulares y cuadradas con proporciones perfectas que alternan elementos Vein Cut y Cross Cut.

Composizione di tessere triangolari e quadrate dalle proporzioni perfette alternano elementi Vein Cut e Cross Cut.

Komposition aus dreieckigen und quadratischen Fliesen mit perfekten Proportionen, bei der sich Vein Cut und Cross Cut-Elemente abwechseln.

В композиции из треугольных и квадратных элементов чередуются поверхности Vein Cut и Cross Cut.



© Ceramiche Atlas Concorde

Origami

Designed by
HBA

Inspired by the ancient Japanese art of folding paper, the mosaic creates the optical illusion of diamonds emerging from a flat surface.

Inspirato all'antica arte giapponese di piegare la carta, il mosaico crea l'illusione ottica di rombi che emergono dalla superficie piana.

Inspirée de l'ancien art japonais du pliage du papier, la mosaïque crée l'illusion optique de formes en diamant émergeant de la surface plane.

Inspiriert von der alten japanischen Kunst des Papierfaltens, erzeugt das Mosaik die optische Täuschung von Diamantformen, die aus der flachen Oberfläche hervortreten.

Inspirado en el antiguo arte japonés de doblar papel, el mosaico crea la ilusión óptica de rombos que emergen de la superficie plana.

Мозаика, отсылающая к старинному японскому искусству сгибания бумаги, создает оптическую иллюзию ромбов, рельефно выступающих на плоской поверхности.



© Ceramiche Atlas Concorde

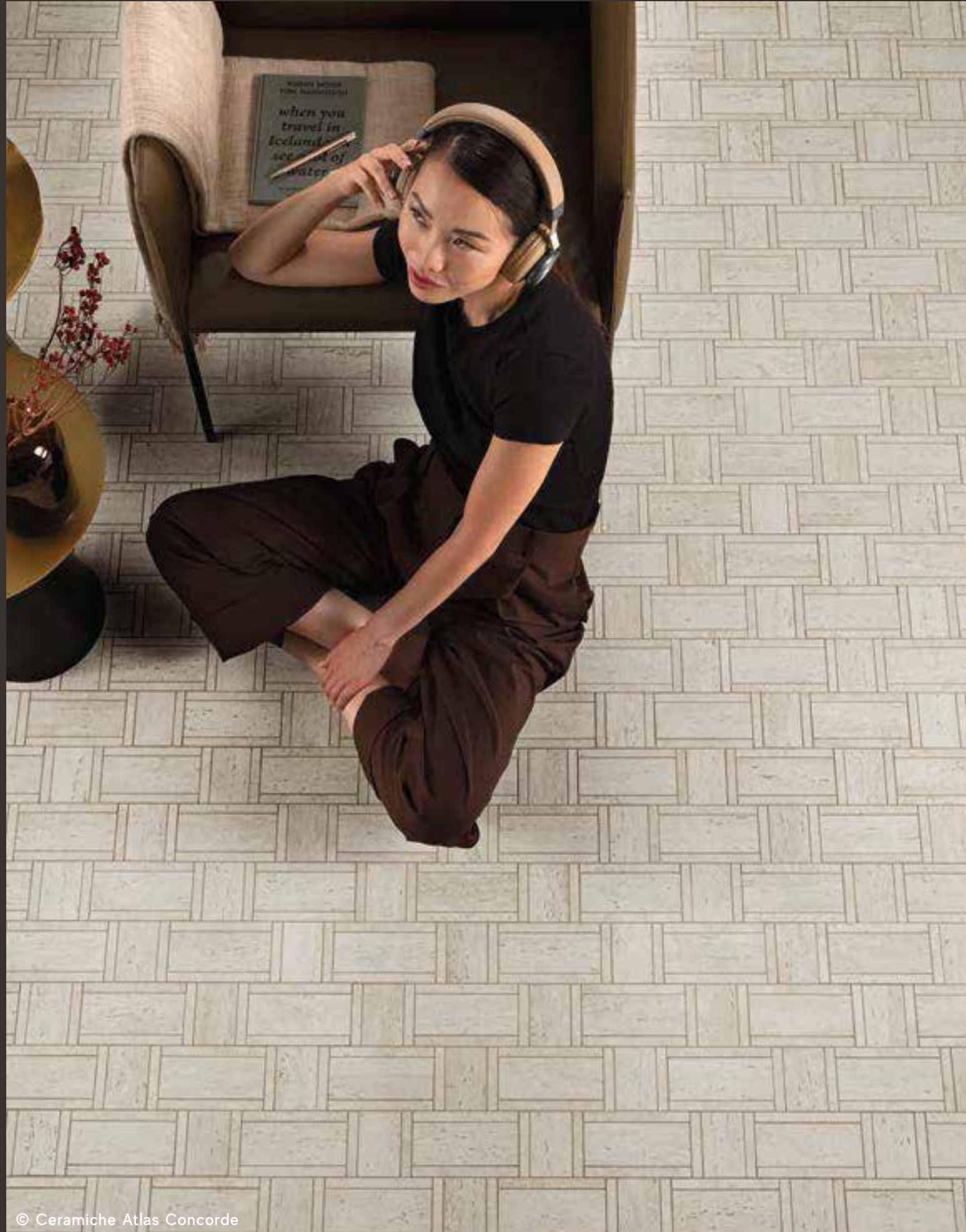

© Ceramiche Atlas Concorde



© Ceramiche Atlas Concorde

Basketweave

Designed by  HBA

Weave of tiles enhanced by the directionality of the veins in the Vein Cut tiles. Small details in the Cross Cut variant make it suitable for all the surfaces of the collection.

Un tissage de carreaux mis en valeur par la direction Vein Cut. Les petits détails de Cross Cut permettent de le combiner avec toutes les surfaces de la collection.

Trama de baldosas realizada por la direccionalidad de las vetas de Vein Cut. Los pequeños detalles de Cross Cut hacen que pueda combinarse con todas las superficies de la colección.

Intreccio di tessere valorizzato dalla direzionalità delle venature Vein Cut. Piccoli dettagli in Cross Cut lo rendono abbinabile a tutte le superfici della collezione.

Ein Geflecht von Fliesen, das durch die Richtung der Vein Cut-Adern hervorgehoben wird. Kleine Details in Cross Cut machen es mit allen Oberflächen der Kollektion kombinierbar.

Переплетение элементов, подчеркнутое направленностью прожилок Vein Cut. Маленькие детали Cross Cut позволяют сочетать декор со всеми плитками коллекции.



© Ceramiche Atlas Concorde



© Ceramiche Atlas Concorde

Chiselled Urban Grid

Designed by **HBA**

Inspired by the geometric urban pattern of metropolitan cities, the decor features a succession of linear incisions.

Inspiré par les schémas urbains géométriques des métropoles, le décor est défini par une succession d'incisions linéaires.

Inspirada en los esquemas urbanos geométricos de las ciudades metropolitanas, la decoración se define por una sucesión de incisiones lineales.

Ispirato agli schemi urbanistici geometrici delle città metropolitane, il decoro è definito dal susseguirsi di incisioni lineari.

Inspiriert von den geometrischen Grundrissen der Großstädte, wird das Dekor durch eine Abfolge von linearen Einschnitten bestimmt.

Декор, напоминающий геометрический облик мегаполисов, предлагает последовательность линейных насечек.

Image Gallery

ENJOY THE VIDEO



EN | IT | FR | DE | RU

OVERVIEW



HBA
HIRSCH
BEDNER
ASSOCIATES



IMAGE
GALLERY



EXCLUSIVE APARTMENT
RESIDENTIAL BATHROOM
LUXURY SHOWROOM
POOL VILLA
MODERN VILLA

SURFACE
RANGE &
TECHNICAL
SPECS.



MARVEL WORLD



WE CARE



Exclusive Apartment - White Vein Cut



Residential Bathroom - Pearl Vein Cut



Luxury Showroom - Sand Vein Cut



Pool Villa - Sand Vein Cut & Cross Cut



Modern Villa - Sand Vein Cut & Cross Cut



Exclusive apartment.



© Ceramiche Atlas Concorde

FLOOR
 Marvel Travertine **White Vein Cut**
 Matte/Matt
 120x240 cm | 47¹/₄"x94¹/₂"

WALL
 Marvel Travertine **White Vein Cut**
 Matte/Matt
 120x278 cm | 47¹/₄"x109¹/₂"

Marvel Travertine **Pearl Vein Cut**
 Matte/Matt
 120x278 cm | 47¹/₄"x109¹/₂"

INDEX



ENJOY THE VIDEO



EN | IT | FR | DE | RU

OVERVIEW



HBA
HIRSCH
BEDNER
ASSOCIATES



IMAGE
GALLERY



EXCLUSIVE APARTMENT
 RESIDENTIAL BATHROOM
 LUXURY SHOWROOM
 POOL VILLA
 MODERN VILLA

SURFACE
RANGE &
TECHNICAL
SPECS.



MARVEL WORLD



WE CARE





FLOOR
 Marvel Travertine **White Vein Cut**
 Matte/Matt
 120x240 cm | 47 1/4" x 94 1/2"

© Ceramiche Atlas Concorde

INDEX



ENJOY THE VIDEO



EN | IT | FR | DE | RU

OVERVIEW



HBA
HIRSCH
BEDNER
ASSOCIATES



IMAGE
GALLERY



EXCLUSIVE APARTMENT

RESIDENTIAL BATHROOM

LUXURY SHOWROOM

POOL VILLA

MODERN VILLA

SURFACE
RANGE &
TECHNICAL
SPECS.



MARVEL WORLD



WE CARE



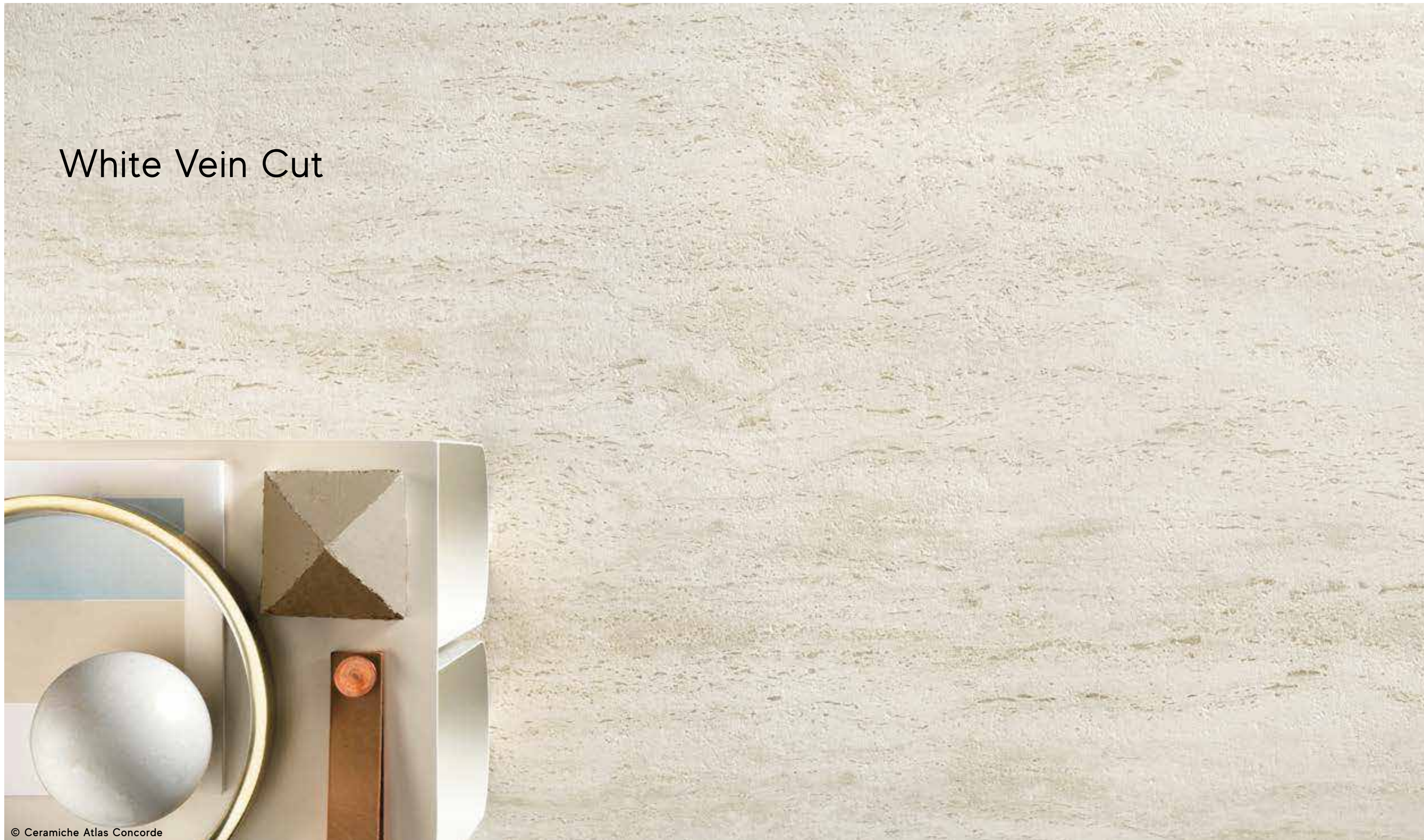

White Vein Cut

© Ceramiche Atlas Concorde

INDEX



ENJOY THE VIDEO



EN | IT | FR | DE | RU

OVERVIEW



HBA
HIRSCH
BEDNER
ASSOCIATES



IMAGE
GALLERY



EXCLUSIVE APARTMENT

RESIDENTIAL BATHROOM

LUXURY SHOWROOM

POOL VILLA

MODERN VILLA

SURFACE
RANGE &
TECHNICAL
SPECS.



MARVEL WORLD



WE CARE





FLOOR
Marvel Travertine **White Vein Cut**
Matte/Matt
120x240 cm | 47¹/₄"x94¹/₂"

WALL
Marvel Travertine **Pearl Vein Cut**
Matte/Matt
120x278 cm | 47¹/₄"x109¹/₂"

COUNTERTOP
Atlas Plan
Travertino Pearl
Hammered
162x324 cm | 63³/₄"x127¹/₂"

INDEX



ENJOY THE VIDEO



EN | IT | FR | DE | RU

OVERVIEW



HBA
HIRSCH
BEDNER
ASSOCIATES



IMAGE
GALLERY



- EXCLUSIVE APARTMENT
- RESIDENTIAL BATHROOM
- LUXURY SHOWROOM
- POOL VILLA
- MODERN VILLA

SURFACE
RANGE &
TECHNICAL
SPECS.



MARVEL WORLD



WE CARE





© Ceramiche Atlas Concorde

FLOOR
 Marvel Travertine **Pearl Vein Cut**
 Outdoor ± 20mm
 60x120 cm | 23⁵/₈"x47¹/₄"

WALL
 Marvel Travertine **Pearl Vein Cut**
 Matte/Matt
 120x278 cm | 47¹/₄"x109¹/₂"

COUNTERTOP
 Atlas Plan
Travertino Pearl
 Hammered
 162x324 cm | 63³/₄"x127¹/₂"

FURNITURE
 Atlas Plan
Desert Soul
 Polished/Lappato
 162x324 cm | 63³/₄"x127¹/₂"

INDEX



ENJOY THE VIDEO



EN | IT | FR | DE | RU

OVERVIEW



HBA HIRSCH BEDNER ASSOCIATES



IMAGE GALLERY



- EXCLUSIVE APARTMENT
- RESIDENTIAL BATHROOM
- LUXURY SHOWROOM
- POOL VILLA
- MODERN VILLA

SURFACE RANGE & TECHNICAL SPECS.



MARVEL WORLD



WE CARE



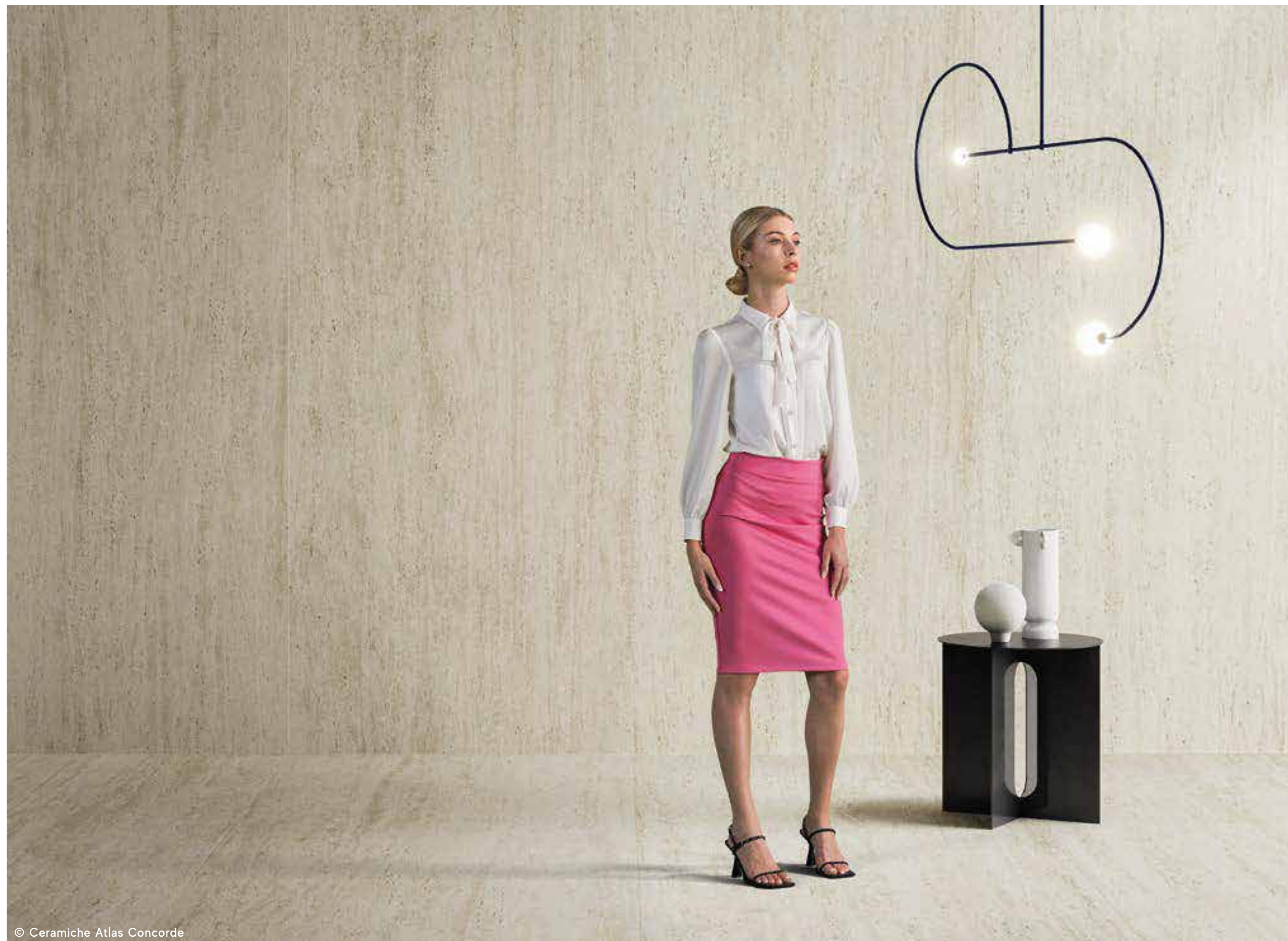

FLOOR
 Marvel Travertine **White Vein Cut**
 Matte/Matt
 120x240 cm | 47¹/₄"x94¹/₂"

WALL
 Marvel Travertine **White Vein Cut**
 Matte/Matt
 120x278 cm | 47¹/₄"x109¹/₂"

© Ceramiche Atlas Concorde

INDEX 

ENJOY THE VIDEO 

EN | IT | FR | DE | RU

OVERVIEW 

HBA
HIRSCH
BEDNER
ASSOCIATES 

IMAGE
GALLERY 

EXCLUSIVE APARTMENT

RESIDENTIAL BATHROOM

LUXURY SHOWROOM

POOL VILLA

MODERN VILLA

SURFACE
RANGE &
TECHNICAL
SPECS. 

MARVEL WORLD 

WE CARE 

© Ceramiche Atlas Concorde

Marvel Travertine

Tessellation

Designed by
HBA

WHITE



INDEX



ENJOY THE VIDEO



EN | IT | FR | DE | RU

OVERVIEW



HBA
HIRSCH
BEDNER
ASSOCIATES



IMAGE
GALLERY



EXCLUSIVE APARTMENT
 RESIDENTIAL BATHROOM
 LUXURY SHOWROOM
 POOL VILLA
 MODERN VILLA

SURFACE
RANGE &
TECHNICAL
SPECS.



MARVEL WORLD



WE CARE



Residential bathroom.



© Ceramiche Atlas Concorde

FLOOR
 Marvel Travertine **Pearl Vein Cut**
 Matte/Matt
 120x240 cm | 47¹/₄"x94¹/₂"

WALL
 Marvel Travertine **Pearl Vein Cut**
 Matte/Matt
 120x278 cm | 47¹/₄"x109¹/₂"

Marvel Travertine **Pearl Chiselled Urban Grid**
 30x60 cm | 11³/₄"x23⁵/₈"



© Ceramiche Atlas Concorde



© Ceramiche Atlas Concorde

FLOOR
 Marvel Travertine **Pearl Vein Cut**
 Matte/Matt
 120x240 cm | 47¹/₄"x94¹/₂"

WALL
 Marvel Travertine **Pearl Vein Cut**
 Matte/Matt
 120x278 cm | 47x109¹/₂"

SINK
 Atlas Concorde Habitat
 Mastertop Marvel Travertine **Pearl Vein Cut**
 Matte/Matt
 180x50x12 cm | 70⁵/₈"x 19⁵/₈"x4³/₄"

INDEX



ENJOY THE VIDEO



EN | IT | FR | DE | RU

OVERVIEW



HBA
HIRSCH
BEDNER
ASSOCIATES



IMAGE
GALLERY



EXCLUSIVE APARTMENT
 RESIDENTIAL BATHROOM
 LUXURY SHOWROOM
 POOL VILLA
 MODERN VILLA

SURFACE
RANGE &
TECHNICAL
SPECS.



MARVEL WORLD



WE CARE





© Ceramiche Atlas Concorde



© Ceramiche Atlas Concorde

FLOOR
 Marvel Travertine **Pearl Vein Cut**
 Matte/Matt
 120x240 cm | 47¹/₄"x94¹/₂"

WALL
 Marvel Travertine **Pearl Chiselled Urban Grid**
 30x60 cm | 11³/₄"x23³/₈"

INDEX



ENJOY THE VIDEO



EN | IT | FR | DE | RU

OVERVIEW



HBA HIRSCH BEDNER ASSOCIATES



IMAGE GALLERY



EXCLUSIVE APARTMENT
 RESIDENTIAL BATHROOM
 LUXURY SHOWROOM
 POOL VILLA
 MODERN VILLA

SURFACE RANGE & TECHNICAL SPECS.



MARVEL WORLD



WE CARE





Pearl Vein Cut

INDEX



ENJOY THE VIDEO



EN | IT | FR | DE | RU

OVERVIEW



HBA
HIRSCH
BEDNER
ASSOCIATES



IMAGE
GALLERY



EXCLUSIVE APARTMENT
RESIDENTIAL BATHROOM
LUXURY SHOWROOM
POOL VILLA
MODERN VILLA

SURFACE
RANGE &
TECHNICAL
SPECS.



MARVEL WORLD



WE CARE





© Ceramiche Atlas Concorde

FLOOR
 Marvel Travertine **Pearl Vein Cut**
 Matte/Matt
 120x240 cm | 47¹/₄"x94¹/₂"

WALL
 Marvel Travertine **Pearl Vein Cut**
 Matte/Matt
 120x278 cm | 47¹/₄"x109¹/₂"



© Ceramiche Atlas Concorde

INDEX



ENJOY THE VIDEO



EN | IT | FR | DE | RU

OVERVIEW



HBA
HIRSCH
BEDNER
ASSOCIATES



IMAGE
GALLERY



EXCLUSIVE APARTMENT
RESIDENTIAL BATHROOM

LUXURY SHOWROOM
POOL VILLA
MODERN VILLA

SURFACE
RANGE &
TECHNICAL
SPECS.



MARVEL WORLD



WE CARE



© Ceramiche Atlas Concorde

Marvel Travertine

Chiselled Urban Grid

Designed by
HBA



PEARL

INDEX



ENJOY THE VIDEO



EN | IT | FR | DE | RU

OVERVIEW



HBA
HIRSCH
BEDNER
ASSOCIATES



IMAGE GALLERY



EXCLUSIVE APARTMENT
RESIDENTIAL BATHROOM
LUXURY SHOWROOM
POOL VILLA
MODERN VILLA

SURFACE RANGE & TECHNICAL SPECS.



MARVEL WORLD



WE CARE



Luxury showroom.



© Ceramiche Atlas Concorde

FLOOR
 Marvel Travertine **Sand Vein Cut**
 Matte/Matt
 120x240 cm | 47¹/₄"x94¹/₂"

Marvel Travertine **White Vein Cut**
 Matte/Matt
 120x240 cm | 47¹/₄"x94¹/₂"

WALL
 Marvel Travertine **Sand Vein Cut**
 Matte/Matt
 120x278 cm | 47¹/₄"x109¹/₂"

Marvel Travertine **White Vein Cut**
 Matte/Matt
 120x278 cm | 47¹/₄"x109¹/₂"

Marvel Travertine **Diamond White**
 60x60 cm | 23⁵/₈"x23⁵/₈"

FURNITURE
 Marvel Travertine **Sand Vein Cut**
 Matte/Matt
 120x278 cm | 47¹/₄"x109¹/₂"

Boost Natural **Coral**
 Matte/Matt
 120x278 cm | 47¹/₄"x109¹/₂"

INDEX



ENJOY THE VIDEO



EN | IT | FR | DE | RU

OVERVIEW



HBA
HIRSCH
BEDNER
ASSOCIATES



IMAGE
GALLERY



EXCLUSIVE APARTMENT
RESIDENTIAL BATHROOM
LUXURY SHOWROOM

POOL VILLA
MODERN VILLA

SURFACE
RANGE &
TECHNICAL
SPECS.



MARVEL WORLD



WE CARE





© Ceramiche Atlas Concorde



© Ceramiche Atlas Concorde

FLOOR
 Marvel Travertine **Sand Vein Cut**
 Matte/Matt
 120x240 cm | 47¹/₄"x94¹/₂"

Marvel Travertine **White Vein Cut**
 Matte/Matt
 120x240 cm | 47¹/₄"x94¹/₂"

WALL
 Marvel Travertine **Sand Vein Cut**
 Matte/Matt
 120x278 cm | 47¹/₄"x109¹/₂"

Marvel Travertine **White Vein Cut**
 Matte/Matt
 120x278 cm | 47¹/₄"x109¹/₂"

FURNITURE
 Marvel Travertine **Sand Vein Cut**
 Matte/Matt
 120x278 cm | 47¹/₄"x109¹/₂"

Boost Natural **Coral**
 Matte/Matt
 120x278 cm | 47¹/₄"x109¹/₂"

INDEX



ENJOY THE VIDEO



EN | IT | FR | DE | RU

OVERVIEW



HBA
HIRSCH
BEDNER
ASSOCIATES



IMAGE
GALLERY



EXCLUSIVE APARTMENT
RESIDENTIAL BATHROOM
LUXURY SHOWROOM

POOL VILLA
MODERN VILLA

SURFACE
RANGE &
TECHNICAL
SPECS.



MARVEL WORLD



WE CARE





© Ceramiche Atlas Concorde

INDEX



ENJOY THE VIDEO



EN | IT | FR | DE | RU

OVERVIEW



HBA HIRSCH BEDNER ASSOCIATES



IMAGE GALLERY



EXCLUSIVE APARTMENT
RESIDENTIAL BATHROOM
LUXURY SHOWROOM

POOL VILLA
MODERN VILLA

SURFACE RANGE & TECHNICAL SPECS.



MARVEL WORLD



WE CARE



FLOOR
Marvel Travertine **Sand Vein Cut**
Matte/Matt
120x240 cm | 47¹/₄"x94¹/₂"

Marvel Travertine **White Vein Cut**
Matte/Matt
120x240 cm | 47¹/₄"x94¹/₂"

WALL
Marvel Travertine **Sand Vein Cut**
Matte/Matt
120x278 cm | 47¹/₄"x109¹/₂"

Marvel Travertine **White Vein Cut**
Matte/Matt
120x278 cm | 47¹/₄"x109¹/₂"

Marvel Travertine **Diamond White**
60x60 cm | 23⁵/₈"x23⁵/₈"

FURNITURE
Marvel Travertine **Sand Vein Cut**
Matte/Matt
120x278 cm | 47¹/₄"x109¹/₂"

Boost Natural **Coral**
Matte/Matt
120x278 cm | 47¹/₄"x109¹/₂"



© Ceramiche Atlas Concorde

FLOOR
 Marvel Travertine **Sand Vein Cut**
 Matte/Matt
 120x240 cm | 47¹/₂"x94¹/₂"

WALL
 Marvel Travertine **Sand Vein Cut**
 Matte/Matt
 120x278 cm | 47¹/₂"x109¹/₂"

INDEX



ENJOY THE VIDEO



EN | IT | FR | DE | RU

OVERVIEW



HBA
HIRSCH
BEDNER
ASSOCIATES



IMAGE
GALLERY



EXCLUSIVE APARTMENT
RESIDENTIAL BATHROOM
LUXURY SHOWROOM

POOL VILLA
MODERN VILLA

SURFACE
RANGE &
TECHNICAL
SPECS.



MARVEL WORLD



WE CARE





© Ceramiche Atlas Concorde

Marvel Travertine

Diamond

Designed by
HBA

PEARL

INDEX



ENJOY
THE VIDEO



EN | IT | FR | DE | RU

OVERVIEW



HBA
HIRSCH
BEDNER
ASSOCIATES



IMAGE
GALLERY



EXCLUSIVE APARTMENT
RESIDENTIAL BATHROOM
LUXURY SHOWROOM

POOL VILLA
MODERN VILLA

SURFACE
RANGE &
TECHNICAL
SPECS.



MARVEL WORLD



WE CARE



Pool villa.



FLOOR
 Marvel Travertine **Sand Vein Cut**
 Outdoor ✂ 20mm
 60x120 cm | 23⁵/₈"x47¹/₄"

Marvel Travertine **White Vein Cut**
 Outdoor ✂ 20mm
 60x120 cm | 23⁵/₈"x47¹/₄"

WALL
 Marvel Travertine **Sand Cross Cut**
 Matte/Matt Sensitech
 60x120 cm | 23⁵/₈"x47¹/₄"

© Ceramiche Atlas Concorde

INDEX



ENJOY THE VIDEO



EN | IT | FR | DE | RU

OVERVIEW



HBA HIRSCH BEDNER ASSOCIATES



IMAGE GALLERY



EXCLUSIVE APARTMENT
RESIDENTIAL BATHROOM
LUXURY SHOWROOM

POOL VILLA

MODERN VILLA

SURFACE RANGE & TECHNICAL SPECS.



MARVEL WORLD



WE CARE





© Ceramiche Atlas Concorde

FLOOR
 Marvel Travertine **Sand Vein Cut**
 Outdoor ✂ 20mm
 60x120 cm | 23⁵/₈"x47¹/₄"

Marvel Travertine **White Vein Cut**
 Outdoor ✂ 20mm
 60x120 cm | 23⁵/₈"x47¹/₄"

WALL
 Marvel Travertine **Sand Cross Cut**
 Matte/Matt Sensitech
 60x120 cm | 23⁵/₈"x47¹/₄"



© Ceramiche Atlas Concorde

INDEX



ENJOY THE VIDEO



EN | IT | FR | DE | RU

OVERVIEW



HBA
HIRSCH
BEDNER
ASSOCIATES



IMAGE
GALLERY



EXCLUSIVE APARTMENT
RESIDENTIAL BATHROOM
LUXURY SHOWROOM

POOL VILLA

MODERN VILLA

SURFACE
RANGE &
TECHNICAL
SPECS.



MARVEL WORLD



WE CARE



© Ceramiche Atlas Concorde



FLOOR
 Marvel Travertine **Sand Cross Cut**
 Matte/Matt Sensitech
 120x120 cm | 47 1/4" x 47 1/4"

INDEX



ENJOY THE VIDEO



EN | IT | FR | DE | RU

OVERVIEW



HBA
HIRSCH
BEDNER
ASSOCIATES



IMAGE
GALLERY



EXCLUSIVE APARTMENT
 RESIDENTIAL BATHROOM
 LUXURY SHOWROOM
 POOL VILLA
 MODERN VILLA

SURFACE
RANGE &
TECHNICAL
SPECS.



MARVEL WORLD



WE CARE





© Ceramiche Atlas Concorde

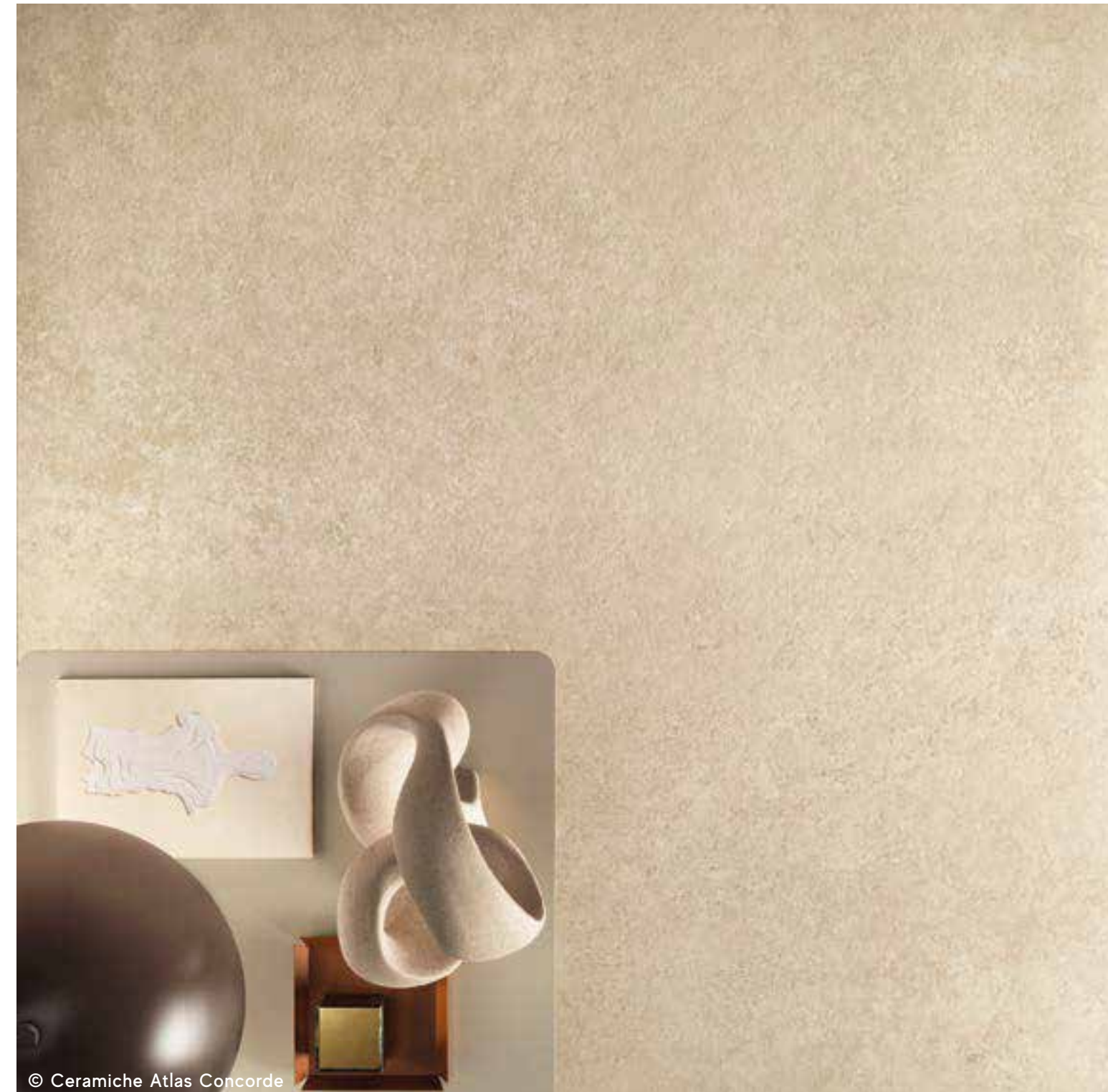

© Ceramiche Atlas Concorde

FLOOR
 Marvel Travertine **Sand Cross Cut**
 Matte/Matt Sensitech
 120x120 cm | 47¹/₄"x47¹/₄"

WALL
 Marvel Travertine **Sand Vein Cut**
 Matte/Matt
 120x278 cm | 47¹/₄"x109¹/₂"

Marvel Travertine **White Vein Cut**
 Matte/Matt
 120x278 cm | 47¹/₄"x109¹/₂"

INDEX 

ENJOY THE VIDEO 

EN | IT | FR | DE | RU

OVERVIEW 

HBA
HIRSCH
BEDNER
ASSOCIATES 

IMAGE
GALLERY 

EXCLUSIVE APARTMENT
RESIDENTIAL BATHROOM
LUXURY SHOWROOM

POOL VILLA

MODERN VILLA

SURFACE
RANGE &
TECHNICAL
SPECS. 

MARVEL WORLD 

WE CARE 



© Ceramiche Atlas Concorde

FLOOR
 Marvel Travertine **Sand Cross Cut**
 Matte/Matt Sensitech
 120x120 cm | 47¹/₄"x47¹/₄"

WALL
 Marvel Travertine **Sand Vein Cut**
 Matte/Matt
 120x278 cm | 47¹/₄"x109¹/₂"

Marvel Travertine **Sand Cross Cut**
 Matte/Matt Sensitech
 60x120 cm | 23³/₈"x47¹/₄"



© Ceramiche Atlas Concorde

INDEX



ENJOY THE VIDEO



EN | IT | FR | DE | RU

OVERVIEW



HBA HIRSCH BEDNER ASSOCIATES



IMAGE GALLERY



EXCLUSIVE APARTMENT
RESIDENTIAL BATHROOM
LUXURY SHOWROOM

POOL VILLA

MODERN VILLA

SURFACE RANGE & TECHNICAL SPECS.



MARVEL WORLD



WE CARE





© Ceramiche Atlas Concorde

WALL
Marvel Travertine Pearl
Chiselled Urban Grid
30x60 cm | 11³/₄"x23⁵/₈"

INDEX



ENJOY THE VIDEO



EN | IT | FR | DE | RU

OVERVIEW



HBA
HIRSCH
BEDNER
ASSOCIATES



IMAGE
GALLERY



EXCLUSIVE APARTMENT
RESIDENTIAL BATHROOM
LUXURY SHOWROOM

POOL VILLA

MODERN VILLA

SURFACE
RANGE &
TECHNICAL
SPECS.



MARVEL WORLD



WE CARE



© Ceramiche Atlas Concorde

Marvel Travertine

Basketweave

Designed by
HBA



WHITE

INDEX



ENJOY THE VIDEO



EN | IT | FR | DE | RU

OVERVIEW



HBA
HIRSCH
BEDNER
ASSOCIATES



IMAGE GALLERY



EXCLUSIVE APARTMENT
RESIDENTIAL BATHROOM
LUXURY SHOWROOM
POOL VILLA
MODERN VILLA

SURFACE RANGE & TECHNICAL SPECS.



MARVEL WORLD



WE CARE



Modern villa.



© Ceramiche Atlas Concorde

FLOOR
 Marvel Travertine **Sand Cross Cut**
 Grip
 60x120 cm | 23⁵/₈"x47¹/₄"

Marvel Travertine **Sand Cross Cut**
 Elemento L Grip
 33x120 h 4 cm | 13"x47¹/₄" h 1⁵/₈"

FACADE
 Marvel Travertine **Sand Vein Cut**
 Matte/Matt Sensitech
 60x120 cm | 23⁵/₈"x47¹/₄"

INDEX



ENJOY THE VIDEO



EN | IT | FR | DE | RU

OVERVIEW



HBA
HIRSCH
BEDNER
ASSOCIATES



IMAGE
GALLERY



EXCLUSIVE APARTMENT
 RESIDENTIAL BATHROOM
 LUXURY SHOWROOM
 POOL VILLA
 MODERN VILLA

SURFACE
RANGE &
TECHNICAL
SPECS.



MARVEL WORLD



WE CARE





© Ceramiche Atlas Concorde



© Ceramiche Atlas Concorde

FLOOR
 Marvel Travertine **Sand Cross Cut**
 Grip
 60x120 cm | 23⁵/₈"x47¹/₄"

Marvel Travertine **Sand Cross Cut**
 Elemento L Grip
 33x120 h 4 cm | 13"x47¹/₄" h 1⁵/₈"

INDEX



ENJOY THE VIDEO



EN | IT | FR | DE | RU

OVERVIEW



HBA
HIRSCH
BEDNER
ASSOCIATES



IMAGE
GALLERY



EXCLUSIVE APARTMENT
 RESIDENTIAL BATHROOM
 LUXURY SHOWROOM
 POOL VILLA
 MODERN VILLA

SURFACE
RANGE &
TECHNICAL
SPECS.



MARVEL WORLD



WE CARE





© Ceramiche Atlas Concorde

FLOOR
 Marvel Travertine **Sand Vein Cut**
 Matte/Matt
 120x240 cm | 47¹/₄"x94¹/₂"

WALL
 Marvel Travertine **Sand Vein Cut**
 Matte/Matt
 120x278 cm | 47¹/₄"x109¹/₂"

INDEX



ENJOY THE VIDEO



EN | IT | FR | DE | RU

OVERVIEW



HBA
HIRSCH
BEDNER
ASSOCIATES



IMAGE
GALLERY



EXCLUSIVE APARTMENT
 RESIDENTIAL BATHROOM
 LUXURY SHOWROOM
 POOL VILLA
 MODERN VILLA

SURFACE
RANGE &
TECHNICAL
SPECS.



MARVEL WORLD



WE CARE



© Ceramiche Atlas Concorde

Sand Vein Cut

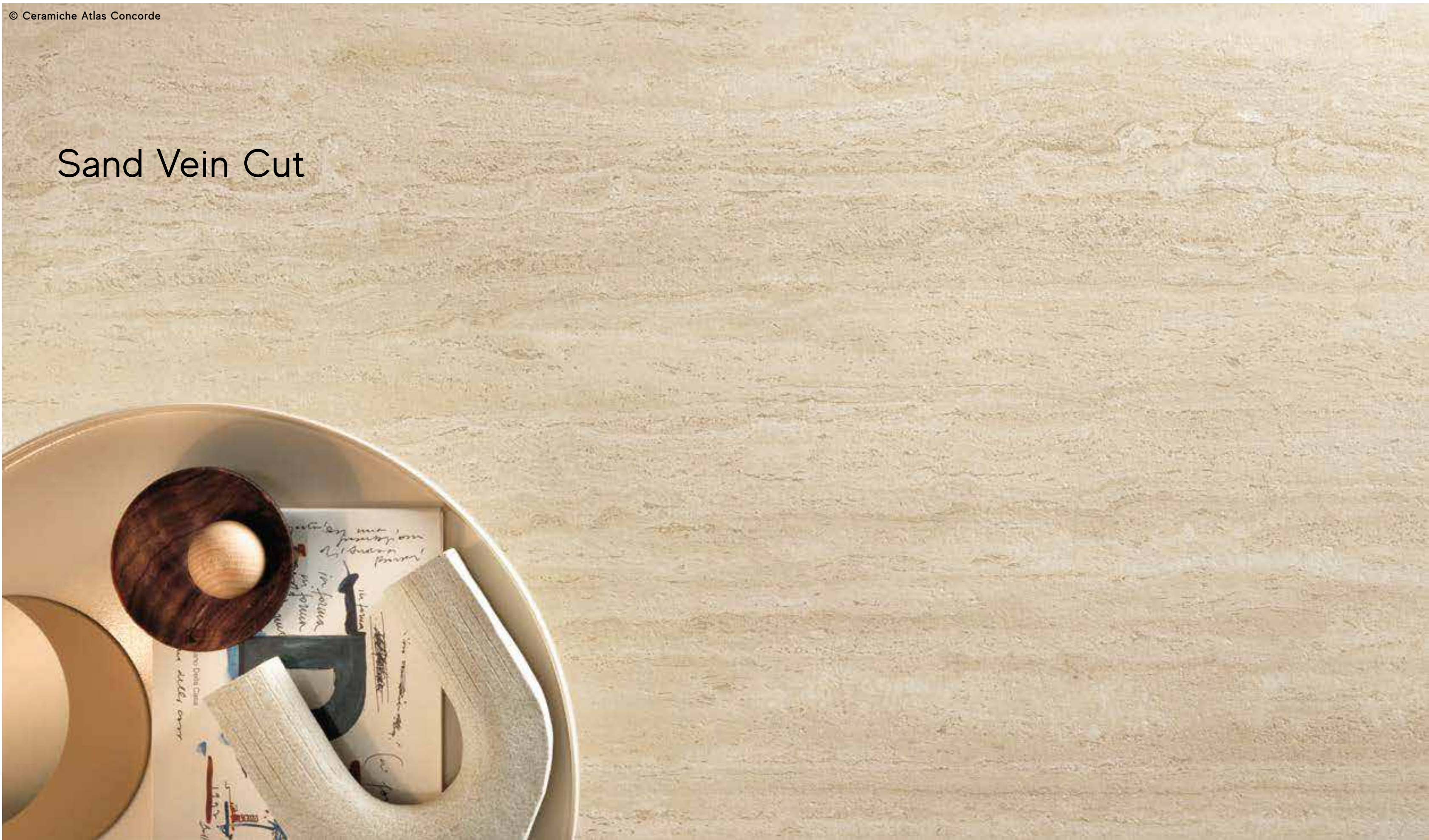

INDEX



ENJOY THE VIDEO



EN | IT | FR | DE | RU

OVERVIEW



HBA
HIRSCH
BEDNER
ASSOCIATES



IMAGE
GALLERY



EXCLUSIVE APARTMENT
RESIDENTIAL BATHROOM
LUXURY SHOWROOM
POOL VILLA
MODERN VILLA

SURFACE
RANGE &
TECHNICAL
SPECS.



MARVEL WORLD



WE CARE





© Ceramiche Atlas Concorde



© Ceramiche Atlas Concorde

FLOOR
 Marvel Travertine **Sand Vein Cut**
 Matte/Matt
 120x240 cm | 47¹/₄"x94¹/₂"

WALL
 Marvel Travertine **Sand Vein Cut**
 Matte/Matt
 120x278 cm | 47¹/₄"x109¹/₂"

COUNTERTOP
 Atlas Plan
 Travertino **Sand**
 Hammered
 162x324 cm | 63³/₄"x127¹/₂"

ENJOY THE VIDEO



EN | IT | FR | DE | RU

OVERVIEW



HBA
HIRSCH
BEDNER
ASSOCIATES



IMAGE
GALLERY



EXCLUSIVE APARTMENT
RESIDENTIAL BATHROOM
LUXURY SHOWROOM
POOL VILLA
MODERN VILLA

SURFACE
RANGE &
TECHNICAL
SPECS.



MARVEL WORLD



WE CARE





© Ceramiche Atlas Concorde

FLOOR
 Marvel Travertine **Sand Vein Cut**
 Matte/Matt
 120x240 cm | 47¹/₄"x94¹/₂"

WALL
 Marvel Travertine **Sand Vein Cut**
 Matte/Matt
 120x278 cm | 47¹/₄"x109¹/₂"

SINK & SHELF
 Atlas Concorde Habitat
 Twin wall-mounted sink
 Marvel Travertine **Sand Vein Cut**
 210x50x15 cm | 82²/₈"x19²/₈"x5⁷/₈"

Shelf Marvel Travertine **Sand Vein Cut**
 210x35x5 cm | 82⁵/₈"x13³/₄"x2"



© Ceramiche Atlas Concorde

INDEX



ENJOY THE VIDEO



EN | IT | FR | DE | RU

OVERVIEW



HBA
 HIRSCH
 BEDNER
 ASSOCIATES



IMAGE
 GALLERY



EXCLUSIVE APARTMENT
 RESIDENTIAL BATHROOM
 LUXURY SHOWROOM
 POOL VILLA
 MODERN VILLA

SURFACE
 RANGE &
 TECHNICAL
 SPECS.



MARVEL WORLD



WE CARE





© Ceramiche Atlas Concorde

WALL
 Marvel Travertine Sand Vein Cut
 Matte/Matt
 120x278 cm | 47 1/4" x 109 1/2"

INDEX



ENJOY THE VIDEO



EN | IT | FR | DE | RU

OVERVIEW



HBA
HIRSCH
BEDNER
ASSOCIATES



IMAGE
GALLERY



EXCLUSIVE APARTMENT
RESIDENTIAL BATHROOM
LUXURY SHOWROOM
POOL VILLA
MODERN VILLA

SURFACE
RANGE &
TECHNICAL
SPECS.



MARVEL WORLD



WE CARE





© Ceramiche Atlas Concorde

Marvel Travertine

Origami

Designed by
HBA

SAND

INDEX



ENJOY THE VIDEO



EN | IT | FR | DE | RU

OVERVIEW



HBA
HIRSCH
BEDNER
ASSOCIATES



IMAGE
GALLERY



EXCLUSIVE APARTMENT
RESIDENTIAL BATHROOM
LUXURY SHOWROOM
POOL VILLA
MODERN VILLA

SURFACE
RANGE &
TECHNICAL
SPECS.



MARVEL WORLD



WE CARE





Surface Range & Technical Specs.

- 116 SENSITECH TECHNOLOGY
- 118 MARVEL TRAVERTINE RANGE
- 123 TECHNICAL SPECIFICATIONS
- 124 MARVEL WORLD RANGE

INDEX



ENJOY THE VIDEO



EN | IT | FR | DE | RU

OVERVIEW



HBA
HIRSCH
BEDNER
ASSOCIATES



IMAGE
GALLERY



SURFACE
RANGE &
TECHNICAL
SPECS.



SENSITECH TECHNOLOGY
COLLECTION RANGE
TECHNICAL SPECIFICATIONS

MARVEL WORLD



WE CARE



The evolution of ceramic surfaces.

ENJOY THE VIDEO
EN | IT | FR | DE | RU

DISCOVER MORE
EN | IT | FR | DE | ES | RU

The constant research of Atlas Concorde Laboratories has led to the creation of Sensitech, the porcelain tile surface made using a production method patented in Italy. Sensitech is a high-tech surface for interiors that combines high slip resistance with an unrivaled soft touch, which also makes it resistant to dirt and easier to clean. With Sensitech the meaning of surface evolves and takes on a reassuring, protective, and pleasantly refined touch, making architectural spaces increasingly comfortable and appealing.

La recherche constante des Laboratoires Atlas Concorde a créé Sensitech, la surface en grès cérame pour intérieur réalisée avec un procédé de fabrication breveté en Italie. Une surface à haut coefficient technologique pour les espaces intérieurs, en mesure de conjuguer de hautes performances de résistance à la glissance avec une douceur tactile inédite, qui la rend également résistante aux salissures et plus facile à nettoyer. Avec Sensitech, c'est l'acception même d'une surface qui évolue en offrant une caractéristique rassurante, protectrice et agréablement raffinée, qui rend les espaces architecturaux de plus en plus confortables et agréables à vivre.

De la constante investigación de los Laboratorios Atlas Concorde nace Sensitech, la superficie de gres porcelánico para interiores realizada con un método de producción patentado en Italia. Una superficie de alto coeficiente tecnológico capaz de combinar un alto rendimiento de resistencia al deslizamiento con una suavidad táctil sin precedentes, que además la vuelve resistente a la suciedad y más fácil de limpiar. Con Sensitech, el significado de la superficie evoluciona y adquiere un toque tranquilizador, protector y agradablemente refinado, haciendo que los espacios arquitectónicos sean cada vez más cómodos y satisfactorios.

Dalla costante ricerca dei Laboratori Atlas Concorde nasce Sensitech, la superficie in gres porcellanato realizzata con metodo produttivo brevettato in Italia. Una superficie ad alto coefficiente tecnologico per gli ambienti interni, in grado di coniugare elevate prestazioni di resistenza allo scivolamento ad un'inedita morbidezza tattile, che la rende anche resistente allo sporco e più facile da pulire. Con Sensitech il significato di superficie si evolve e assume un tocco rassicurante, protettivo e piacevolmente raffinato, rendendo gli spazi architettonici sempre più confortevoli ed appaganti.

Durch kontinuierliche Forschung der Atlas Concorde Laboratorien entsteht Sensitech, die Feinsteinzeugoberfläche, die mit einem in Italien patentierten Herstellungsverfahren produziert wird. Eine Hightec-Oberfläche für Innenräume, die hohe Rutschfestigkeit mit unerwartet weicher Haptik verbindet, welche sie auch schmutzunempfindlicher und reinigungsfreundlicher macht. Mit Sensitech erreicht die Oberfläche ein ganz neues Niveau in Sachen Zuverlässigkeit, Schutz und Schönheit. Und macht damit unsere Räumlichkeiten noch attraktiver und komfortabler.

В результате исследований, выполненных в лабораториях Atlas Concorde, появилась керамогранитная поверхность Sensitech. Новая поверхность с высокими техническими показателями для интерьеров, которая сочетает отличное сопротивление скольжению и удивительную мягкость на ощупь, устойчива к загрязнениям и крайне проста в чистке и уходе. Поверхность Sensitech – на новом витке технической эволюции, она безопасна, приятна, изысканна и делает пространства уютнее и удобнее.

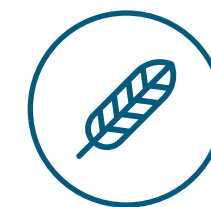

SOFT TO THE TOUCH
MORBIDA AL TATTO



EXTREMELY SAFE
ESTREMAMENTE SICURA

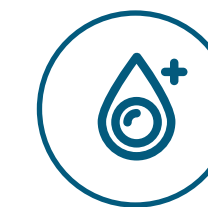

HYGIENIC AND EASY TO CLEAN
IGIENICA E FACILMENTE PULIBILE



LONG-LASTING QUALITIES
QUALITÀ DUREVOLI NEL TEMPO

Surface section magnification (µm)* Ingrandimento di una sezione di superficie (µm)*

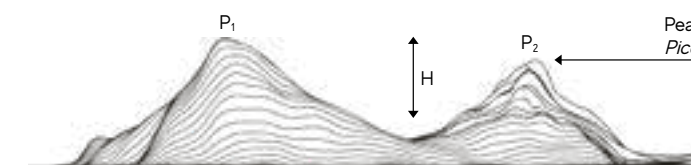

Traditional anti-slip surface
Superficie anti-slip tradizionale

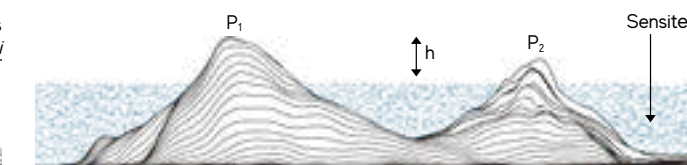

Sensitech surface
Superficie Sensitech

P₁ P₂ Same peaks — same slippery resistance
Picchi invariati — uguale resistenza allo scivolamento

h < H Reduced depth of valleys — smoother surface and greater ease of cleaning
Minore profondità degli avvallamenti — percezione di superficie più liscia e maggiore facilità di pulizia

* Charts not to scale, for illustrative purposes / *Grafici non in scala, a scopo illustrativo*

Porcelain tiles

PORCELAIN TILES - Gres Porcellanato - Grès cérame - Feinsteinzeug - Gres porcelánico - Керамический гранит

RECTIFIED MONOCALIBER - Rettificato monocalibro - Rectifié mono-calibre - Geschliffen einkalibrig - Rectificado monocalibre - Ретифицированный в одном калибре

VEIN CUT

		White	Sand	Pearl
120x278 cm - 47 1/4" x 109 1/2"	± 6 mm	Matte	Matte	Matte
120x240 cm - 47 1/4" x 94 1/2"	± 9 mm	Matte	Matte	Matte
60x120 cm - 23 5/8" x 47 1/4"	± 9 mm	Matte Sensitech (S)	Matte Sensitech (S)	Matte Sensitech (S)
	Atlas Plan			
162x324 cm - 63 3/4" x 127 1/2"	± 12 mm		Hammered	Hammered
> Non rectified - non rettificato				
	Outdoor and Wet Areas			
60x120 cm - 23 5/8" x 47 1/4"	± 9 mm	Grip	Grip	Grip
60x120 cm - 23 5/8" x 47 1/4"	± 20 mm	Outdoor	Outdoor	Outdoor

CROSS CUT

		White	Sand	Pearl
120x120 cm - 47 1/4" x 47 1/4"	± 9 mm	Matte Sensitech (S)	Matte Sensitech (S)	Matte Sensitech (S)
60x120 cm - 23 5/8" x 47 1/4"	± 9 mm	Matte Sensitech (S)	Matte Sensitech (S)	Matte Sensitech (S)
60x60 cm - 23 5/8" x 23 5/8"	± 9 mm	Matte Sensitech (S)	Matte Sensitech (S)	Matte Sensitech (S)
	Outdoor and Wet Areas			
60x120 cm - 23 5/8" x 47 1/4"	± 9 mm	Grip	Grip	Grip



pag.116

The constant research of Atlas Concorde Laboratories has led to the creation of Sensitech, the porcelain tile surface for interiors made using a production method patented in Italy that combines superior slip-resistance with an unprecedented tactile softness, guaranteeing ease of cleaning and maintenance.

Dalla costante ricerca dei Laboratori Atlas Concorde nasce Sensitech, la superficie in gres porcellanato per interni realizzata con metodo produttivo brevettato in Italia, che associa elevate prestazioni di resistenza allo scivolamento ad un'inedita morbidezza tattile, garantendo facilità di pulizia e manutenzione.

Destination of use



Anti-slip



Color-shading

V3 Moderate Variation

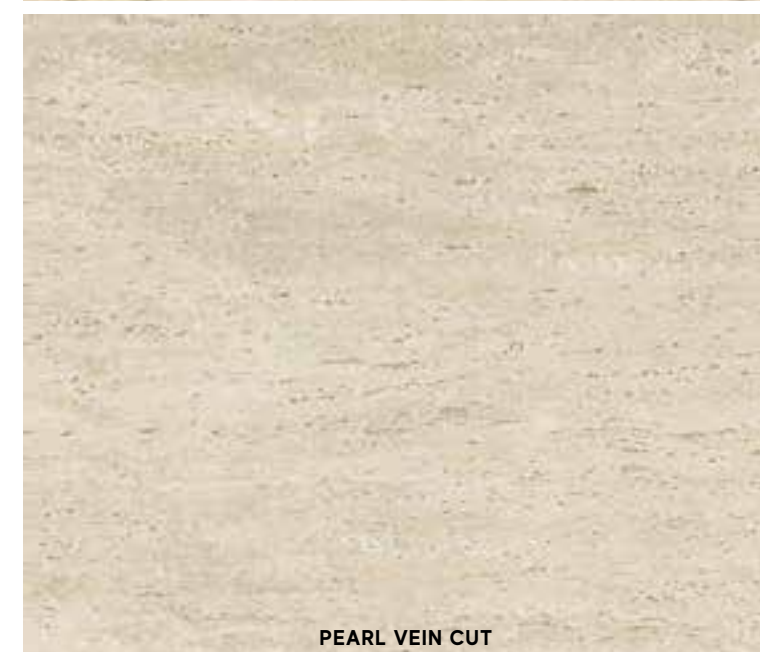
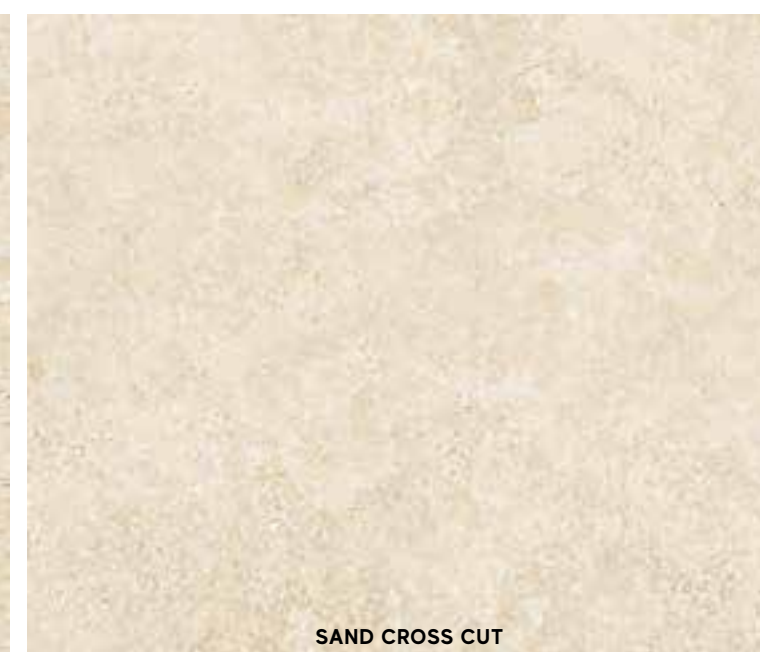

INDEX



ENJOY THE VIDEO



EN | IT | FR | DE | RU

OVERVIEW



HBA HIRSCH BEDNER ASSOCIATES



IMAGE GALLERY



SURFACE RANGE & TECHNICAL SPECS.



SENSITECH TECHNOLOGY

COLLECTION RANGE

TECHNICAL SPECIFICATIONS

MARVEL WORLD



WE CARE



Porcelain Tiles Decors



Marvel Travertine Travertino White
Mosaico Origami
28x41,2 cm - 11"x16¹/₄"



Marvel Travertine Travertino Sand
Mosaico Origami
28x41,2 cm - 11"x16¹/₄"



Marvel Travertine Travertino Pearl
Mosaico Origami
28x41,2 cm - 11"x16¹/₄"

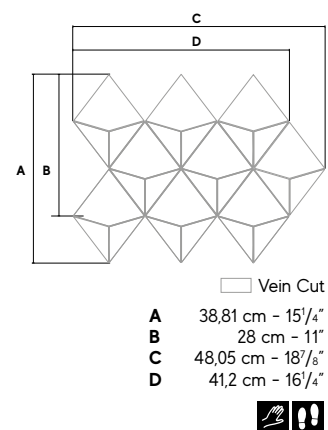

Marvel Travertine Travertino White
Diamond (1)
60x60 cm - 23⁵/₈"x23⁵/₈"



Marvel Travertine Travertino Sand
Diamond (1)
60x60 cm - 23⁵/₈"x23⁵/₈"



Marvel Travertine Travertino Pearl
Diamond (1)
60x60 cm - 23⁵/₈"x23⁵/₈"



Marvel Travertine Travertino White
Mosaico Basketweave
35x46,8 cm - 13³/₄"x18³/₄"



Marvel Travertine Travertino Sand
Mosaico Basketweave
35x46,8 cm - 13³/₄"x18³/₄"



Marvel Travertine Travertino Pearl
Mosaico Basketweave
35x46,8 cm - 13³/₄"x18³/₄"

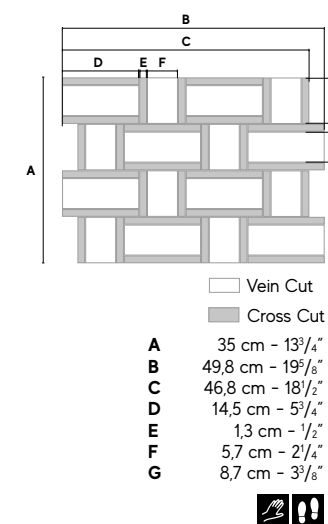

Marvel Travertine Travertino White
Cross Chiselled Urban Grid (2)
30x60 cm - 11³/₄"x23⁵/₈"



Marvel Travertine Travertino Sand
Cross Chiselled Urban Grid (2)
30x60 cm - 11³/₄"x23⁵/₈"



Marvel Travertine Travertino Pearl
Cross Chiselled Urban Grid (2)
30x60 cm - 11³/₄"x23⁵/₈"



For best results it is recommended to follow one of the following laying patterns. - Per un risultato estetico ottimale si consiglia di seguire uno dei seguenti schemi di posa. - Nous vous invitons à respecter un des schémas de pose suivants pour un résultat esthétique optimal. - Für ein optisch optimales Resultat empfehlen wir, eines der nachstehenden Verlegemuster zu befolgen. - Para obtener un mejor resultado estético, es aconsejable seguir uno de los siguientes esquemas de colocación. - Для достижения наилучшего эстетического результата рекомендуется использовать одну из следующих схем укладки.



Marvel Travertine Travertino White
Mosaico Tessellation
22x26 cm - 8⁵/₈"x10¹/₄"



Marvel Travertine Travertino Sand
Mosaico Tessellation
22x26 cm - 8⁵/₈"x10¹/₄"



Marvel Travertine Travertino Pearl
Mosaico Tessellation
22x26 cm - 8⁵/₈"x10¹/₄"

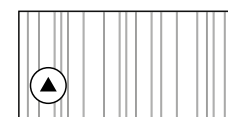
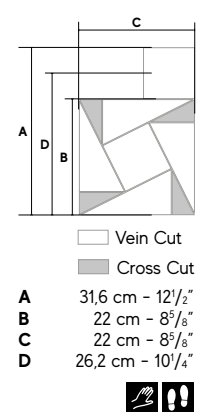

LAYING PATTERN 1

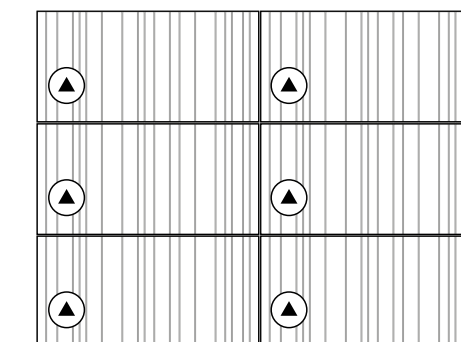

LAYING PATTERN 2

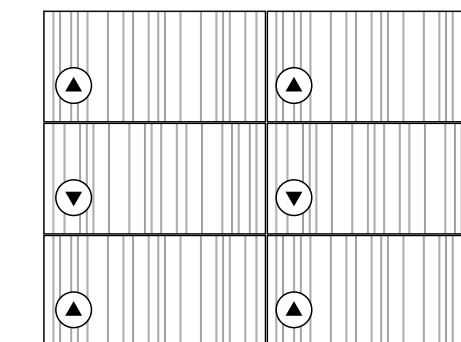

(1) Application of decorative materials. The use of a common mild detergent is recommended. Avoid using acidic or alkaline products, waxes, steel wool, or abrasives. - Applicazione di materie decorative. Si consiglia l'utilizzo di un comune detergente neutro. Evitare l'utilizzo di prodotti acidi o alcalini, ceranti e pagliette di metallo o abrasive. - Application de matériaux décoratifs. Nous conseillons l'emploi de détergents neutres courants. Éviter l'utilisation de cires et de produits acides ou alcalins, ainsi que les pailles métalliques ou abrasives. - Dekorationsmaterial. Es empfiehlt sich, ein haushaltsübliches, neutrales Reinigungsmittel zu verwenden. Saure oder alkalische Produkte, Wachs sowie Stahlwolle- bzw. Scheuerschwämme sind zu vermeiden. - Aplicación de materiales decorativos. Recomendamos utilizar un detergente neutro común. Hay que evitar el uso de productos ácidos o alcalinos, ceras y estropajos de metal o abrasivos. - Применение декоративных материалов. Рекомендуется очистить обычным нейтральным моющим средством. Не рекомендуется использовать кислотные, щелочные, восковые средства, а также металлические моющие средства.

(2) Engraved mosaic. For best results it is advisable to completely plaster the engravings. - Mosaico inciso, per risultato ottimale si consiglia di stuccare completamente le incisioni. - Mosaïque gravée, pour de meilleurs résultats, il est recommandé de remplir complètement les gravures. - Graviertes Mosaik, für ein optimales Resultat sollten die Gravuren vollständig verspachtelt werden. - Mosaico grabado, para obtener los mejores resultados se recomienda enmasillar el grabado en su totalidad. - Высеченная мозаика. Для оптимального результата рекомендуется полностью заделывать углубления затиркой.

Trim tiles

Indoor trim tiles

Marvel Scalino ✓
Vein / Cross Cut
33x120 cm - 13"x47 1/4"

Marvel Battiscopa
Vein / Cross Cut
7,2x120 cm - 2 7/8"x47 1/4"

Marvel Gradino ✓
Vein / Cross Cut
30x120 cm - 11 3/4"x47 1/4"

Marvel Scalino Angolare ✓
Vein / Cross Cut
33x33 cm - 13"x13"

Marvel Battiscopa Sagomato
Vein / Cross Cut Sx/Dx ✓
7,2x30 cm - 2 7/8"x11 3/4"

Outdoor trim tiles

Marvel Elemento L Grip
Vein / Cross Cut ✓
33x120 H.4 cm
13"x47 1/4" x 1 5/8"

Marvel Corner ± 6 mm ✓
Vein Cut
1x120 cm - 3/8"x47 1/4"

✓ These parts are supplied to order / I pezzi sono disponibili su ordinazione

Outdoor trim tiles ± 20 mm

Marvel Round SP * ♦ ✓
33x120 cm - 13"x47 1/4"

Marvel Costa Design SP * ✓
33x120 cm - 13"x47 1/4"

Marvel Elemento L SP * ♦ ✓
33x120 cm - 13"x47 1/4"

Marvel Alzata SP * ✓
20x120 cm - 7 7/8"x47 1/4"

Marvel Top SP * ✓
30x120 cm - 11 3/4"x47 1/4"

- * Available in / Disponibile in White - Sand - Pearl Vein Cut
- ✓ These parts are supplied to order / I pezzi sono disponibili su ordinazione
- ♦ Right-left angular elements are available / Sono disponibili gli elementi angolari dx/sx

Outdoor Porcelain tiles ± 20 mm

For further details on the 20mm thick products, related trim pieces and installation systems - in particular for recommendations and precautions during installation- please refer to the Outdoor Design section on the Atlas Concorde website or to the Outdoor Design catalogue. Per dettagli sul prodotto e sui relativi pezzi speciali in 20mm di spessore, per i sistemi di posa e, in particolare, per raccomandazioni, accorgimenti e precauzioni in fase di posa e progettazione, si raccomanda di prendere visione del catalogo Outdoor Design e della sezione Outdoor Design del sito Atlas Concorde. - Pour plus de renseignements sur le produit, les pièces spéciales de 20mm d'épaisseur et sur les systèmes de pose, ainsi que pour tous conseils et recommandations et précautions d'emploi pendant la pose ou en phase de conception, nous vous recommandons de lire le catalogue Outdoor Design et de consulter la section Outdoor Design sur le site d'Atlas Concorde. - Bitte beachten Sie die detaillierten Informationen zum Produkt und zu den zugehörigen Formteilen in 20mm Stärke, zu den Verlegesystemen sowie vor allem die Empfehlungen, Tipps und bei der Planung und Verlegung zu beachtenden Vorsichtsmaßnahmen, die im Katalog Outdoor Design sowie im Bereich Outdoor Design der Atlas Concorde-Website aufgeführt sind. - Para mayor información sobre el producto y sus relativas piezas especiales de 20mm de grosor, para los sistemas de colocación, y en particular, para las recomendaciones, cautelas y precauciones en la fase de colocación y diseño, se recomienda consultar el catálogo Outdoor Design y la sección Outdoor Design del sitio Atlas Concorde. - Подробное о плитках и о специальных элементах толщиной 20мм, о системах монтажа, о мерах предосторожности при проектировании и укладке можно узнать в каталоге Outdoor Design и в разделе Outdoor Design на сайте Atlas Concorde.

Note

For information and details relating to codes, packaging and weight it is recommended to refer to the latest pricelist. / Per le informazioni e i dati relativi a codici, imballaggi e pesi occorre sempre consultare l'ultimo listino aggiornato e in vigore. / Pour toutes informations et renseignements concernant les codes, les emballages et les poids, il y a toujours lieu de consulter le dernier tarif en vigueur et mis à jour. / Für Informationen und Daten die den Code, die Verpackung und das Gewicht betreffen bitte die aktuellste Preisliste zugrunde legen. / Para acceder a la información y a los datos relativos a códigos, embalajes y pesos hay que consultar siempre la última lista de precios actualizada y vigente. / Для информации о кодах, упаковках и весе обращайтесь к последнему действующему прайс-листу.

Colors and optical features of the materials illustrated in this catalogue are to be regarded as mere indications. / I colori e le caratteristiche estetiche dei materiali illustrati nel presente catalogo sono da ritenersi puramente indicativi. / Les coloris et les caractéristiques esthétiques des références illustrées dans le catalogue sont donnés à titre purement indicatif. / Die Farben und die ästhetischen Eigenschaften der in diesem Katalog abgebildeten Produkte sind als reine Richtwerte zu betrachten. / Los colores y las características estéticas de los materiales ilustrados en el presente catálogo deben ser considerados como puramente indicativos. / Цвета и эстетические характеристики описанных в настоящем каталоге материалов являются только ориентировочными.

Atlas Concorde reserves the right to modify any product without notice and will not be liable for any direct or indirect damage resulting from such modifications. / Atlas Concorde si riserva di modificare i prodotti senza preavviso, declinando ogni responsabilità su eventuali danni diretti o indiretti derivanti da eventuali modifiche. / Atlas Concorde se réserve le droit de modifier ses produits sans préavis et décline toute responsabilité concernant les éventuels dommages directs ou indirects qui pourraient dériver de ces modifications. / Atlas Concorde behält sich das Recht vor jederzeit und ohne vorherige Ankündigung, die Produkte zu verändern, und lehnt jede Haftung bei direkten oder indirekten Schäden ab, die von diesen Veränderungen herrühren. / Atlas Concorde se reserva el derecho de modificar los productos sin previo aviso, rechaza cualquier responsabilidad sobre eventuales daños directos o indirectos derivados de eventuales modificaciones. / Atlas Concorde оставляет за собой право изменять характеристики изделий без предварительного уведомления, отклоняя при этом любую ответственность за прямые или косвенные убытки, возникшие в результате изменений.



Porcelain tiles - Rectified monocaliber | Gres porcellanato - Rettificato monocalibro

Compliant with standards EN 14411 annex G group Bla
Compliant with standards ISO 13006 annex G group Bla
Conforme alla norma EN 14411 Appendice G gruppo Bla
Conforme alla norma ISO 13006 Appendice G gruppo Bla

120x278 cm - 47 1/4"x109 1/2" ± 6 mm
120x240 cm - 47 1/4"x94 1/2" ± 9 mm
120x120 cm - 47 1/4"x47 1/4" ± 9 mm
60x120 cm - 23 3/8"x47 1/4" ± 9 mm
60x60 cm - 23 3/8"x23 3/8" ± 9 mm

Technical features Caratteristiche tecniche	Test Method Metodo di prova	Requirements for nominal size N / Requisiti per dimensione nominale N						
		7 cm ≤ N < 15 cm		N ≥ 15 cm				
		(mm)	(%)	(mm)				
Length and width Lunghezza e larghezza	ISO 10545-2	± 0,9 (*) Non-rect. ± 0,4 (*) Rect.	± 0,6 (*) Non-rect. ± 0,3 (*) Rect.	± 2,0 (*) Non-rect. ± 1,0 (*) Rect.	Matte, Matte Sensitech ± 9 mm	Matte ± 6 mm	Grip ± 9 mm	Outdoor ± 20 mm
Thickness Spessore		± 0,5 (**)	± 5 (**)	± 0,5 (**)	Suitable for Conforme	Suitable for Conforme	Suitable for Conforme	Suitable for Conforme
Straightness of sides Rettilinearità degli spigoli		± 0,8 (***) Non-rect. ± 0,4 (***) Rect.	± 0,5 (***) Non-rect. ± 0,3 (***) Rect.	± 1,5 (***) Non-rect. ± 0,8 (***) Rect.	Suitable for Conforme	Suitable for Conforme	Suitable for Conforme	Suitable for Conforme
Rectangularity (Measurement only on short edges when L/l ≥ 3) Ortogonalità (Misurazione da condurre solo sui lati corti quando L/l ≥ 3)		± 0,8 (****) Non-rect. ± 0,4 (****) Rect.	± 0,5 (****) Non-rect. ± 0,3 (****) Rect.	± 2,0 (****) Non-rect. ± 1,5 (****) Rect.	Suitable for Conforme	Suitable for Conforme	Suitable for Conforme	Suitable for Conforme
Surface flatness Planarità	ISO 10545-2	c.c. ± 0,8 Non-rect. c.c. ± 0,6 Rect. e.c. ± 0,8 Non-rect. e.c. ± 0,6 Rect. w. ± 0,8 Non-rect. w. ± 0,6 Rect.	c.c. ± 0,5 Non-rect. c.c. ± 0,4 Rect. e.c. ± 0,5 Non-rect. e.c. ± 0,4 Rect. w. ± 0,5 Non-rect. w. ± 0,4 Rect.	c.c. ± 2,0 Non-rect. c.c. ± 1,8 Rect. e.c. ± 2,0 Non-rect. e.c. ± 1,8 Rect. w. ± 2,0 Non-rect. w. ± 1,8 Rect.	Suitable for Conforme	Suitable for Conforme	Suitable for Conforme	Suitable for Conforme
Water absorption (in % by mass) Massa d'acqua assorbita (come % della massa)	ISO 10545-3 ASTM C373-18	E _v ≤ 0,5% Individual Maximum 0,6% E _v ≤ 0,5% Valore massimo singolo 0,6%			≤ 0,1 %	≤ 0,1 %	≤ 0,1 %	≤ 0,1 %
Breaking strength Sforzo di rottura	ISO 10545-4	S ≥ 700N (for thickness < 7,5 mm - per spessore < 7,5 mm) S ≥ 1300N (for thickness ≥ 7,5 mm - per spessore ≥ 7,5 mm)			S ≥ 1500 N	S ≥ 1000 N	S ≥ 1500 N	S ≥ 10000 N
Modulus of rupture Resistenza alla flessione	ISO 10545-4	R ≥ 35 N/mm ²			R ≥ 40 N/mm ²	R ≥ 40 N/mm ²	R ≥ 40 N/mm ²	R ≥ 45 N/mm ²
Bending strength and breaking load Resistenza a flessione e al carico di rottura (4)(5)	EN 1339 Annex F	-			-	-	-	≥ U4 60x120
Impact resistance, as coefficient of restitution Resistenza all'impatto, espresso come coefficiente di restituzione	ISO 10545-5	Declared value Valore dichiarato			≥ 0,55	≥ 0,55	≥ 0,55	≥ 0,55
Mohs hardness Durezza Mohs	EN 101	-			6	6	8	8
Resistance to deep abrasion of unglazed tiles (removed volume) Resistenza all'abrasione profonda delle piastrelle non smaltate (volume materiale asportato)	ISO 10545-6	≤ 175 mm ³			≤ 150 mm ³	≤ 150 mm ³	≤ 150 mm ³	≤ 150 mm ³
Coefficient of thermal linear expansion Coefficiente di dilatazione termica lineare	ISO 10545-8	Declared value Valore dichiarato			≤ 7MK ⁻¹	≤ 7MK ⁻¹	≤ 7MK ⁻¹	≤ 7MK ⁻¹
Thermal shock resistance Resistenza agli sbalzi termici	ISO 10545-9	Pass according to EN ISO 10545-1 Test superato in accordo con ISO 10545-1			Resistant Resiste	Resistant Resiste	Resistant Resiste	Resistant Resiste
Moisture expansion (in mm/m) Dilatazione all'umidità (in mm/m)	ISO 10545-10	Declared value Valore dichiarato			≤ 0,01% (0,1mm/m)	≤ 0,01% (0,1mm/m)	≤ 0,01% (0,1mm/m)	≤ 0,01% (0,1mm/m)
Frost resistance Resistenza al gelo	ISO 10545-12	Pass according to EN ISO 10545-1 Test superato in accordo con ISO 10545-1			Resistant Resiste	Resistant Resiste	Resistant Resiste	Resistant Resiste
Bond strength/adhesion for improved cementitious adhesives Adesione a trazione con adesivi cementizi migliorati	EN 1348	Declared value Valore dichiarato			≥ 1,0 N/mm ² (Class C2 - EN 12004)	≥ 1,0 N/mm ² (Class C2 - EN 12004)	≥ 1,0 N/mm ² (Class C2 - EN 12004)	≥ 1,0 N/mm ² (Class C2 - EN 12004)
Reaction to fire Reazione al fuoco	-	Class A1 or A1 _f Classe A1 oppure A1 _f			A1 - A1 _f	A1 - A1 _f	A1 - A1 _f	A1 - A1 _f
Resistance to household chemicals and swimming pool salts Resistenza ai prodotti chimici di uso domestico e agli additivi per piscina	ISO 10545-13	Minimum Class B Classe minima B			A	A	A	A
Resistance to low concentrations of acids and alkalis Resistenza a basse concentrazioni di acidi e alcali		Declared Class Classe dichiarata			LA	LA	LA	LA
Resistance to high concentrations of acids and alkalis Resistenza ad alte concentrazioni di acidi e alcali		Declared Class Classe dichiarata			HA	HA	HA	HA
Resistance to staining, for unglazed tiles Resistenza alle macchie per piastrelle non smaltate	ISO 10545-14	Declared Class Classe dichiarata			5	5	5	5
Shoed Ramp Test Metodo della rampa "calzato"	EN 16165 ANNEX B (EX DIN 51130)	Declared value Valore dichiarato			R10	R9	R11	R11
Barefoot Ramp Test Metodo della rampa a piedi nudi	EN 16165 ANNEX A (EX DIN 51097)	Declared value Valore dichiarato			A+B	A	A+B+C	A+B+C
Pendulum Friction Test Metodo del Pendolo	BS 7976	PTV ≥ 36 classifies the surface as "low slip risk"			≥ 36 Dry ≥ 36 Wet	●	≥ 36 Dry ≥ 36 Wet	≥ 36 Dry ≥ 36 Wet
	AS 4586 UNE-ENV 12633 - UNE 41901:2017 EX	Declared Classification of the new pedestrian surface materials according to the Pendulum Test			Class P3	●●●	Class P4	Class P3
Coefficient of friction (COF) Coefficiente di attrito	B.C.R.A. Rep. CEC/81	D.M. 236/89 del 14/06/89 μ > 0,40 per elemento scivolante cuoio su pavimentazione asciutta μ > 0,40 per elemento scivolante gomma dura su pavimentazione bagnata			> 0,40 Asciutto > 0,40 Bagnato	> 0,40 Asciutto > 0,40 Bagnato	> 0,40 Asciutto > 0,40 Bagnato	> 0,40 Asciutto > 0,40 Bagnato
Dynamic coefficient of friction (DCOF) Coefficiente di attrito dinamico	ANSI A 326.3	-			wet DCOF ≥ 0,50	wet DCOF ≥ 0,42	wet DCOF ≥ 0,55	wet DCOF ≥ 0,55

(*) The permissible deviation, in % or mm, of the average size for each tile (2 or 4 sides) from work size (WS). Deviazione ammissibile, in % oppure mm, della dimensione media di ogni piastrella (2 oppure 4 lati) dalla dimensione di fabbricazione (WS).
 (**) The permissible deviation, in % or mm, of the average thickness for each tile from the work size thickness (WS). Deviazione ammissibile, in % oppure mm, dello spessore medio di ogni piastrella dallo spessore riportato nella dimensione di fabbricazione (WS).
 (***) The maximum permissible deviation from straightness, in % or mm, related to the corresponding work size (WS). Deviazione massima ammissibile di rettinezza, in % oppure mm, in rapporto alle dimensioni di fabbricazione (WS) corrispondenti.
 (****) The maximum permissible deviation from rectangularity, in % or mm, related to the corresponding work size (WS). Deviazione massima ammissibile di ortogonalità, in % oppure mm, in rapporto alle dimensioni di fabbricazione (WS) corrispondenti.
 (c.c.) The maximum permissible deviation from centre curvature, in % or mm, related to diagonal calculated from the work sizes (WS). Deviazione massima ammissibile della curvatura del centro, in % oppure mm, in rapporto alla diagonale calcolata secondo le dimensioni di fabbricazione (WS).
 (e.c.) The maximum permissible deviation from edge curvature, in % or mm, related to the corresponding work size (WS). Deviazione massima ammissibile della curvatura dello spigolo, in % oppure mm, in rapporto alle dimensioni di fabbricazione (WS) corrispondenti.
 (w.) The maximum permissible deviation from warpage, in % or mm, related to diagonal calculated from the work size (WS). Deviazione massima ammissibile dello svergolio, in % oppure mm, in rapporto alla diagonale calcolata secondo le dimensioni di fabbricazione (WS).
 (1) Determination of slip resistance of pedestrian surfaces. It does not cover sports surfaces and road surfaces for vehicles (skid resistance). Determinazione della resistenza allo scivolamento delle superfici pedonabili, non si applica alle pavimentazioni sportive ed alle pavimentazioni stradali veicolanti.
 (2) Anti-slip performance is guaranteed at the time of delivery of the product. Le prestazioni anti-slip vengono garantite al momento della consegna del prodotto.
 (3) However, tiles with a DCOF of 0.42 or greater are not necessarily suitable for all projects. The specifier shall determine tiles appropriate for specific project conditions, considering by way of example, but not in limitation, type of use, traffic, expected contaminants, expected maintenance, expected wear, and manufacturers' guidelines and recommendations.
 (4) For further details, please refer to outdoor design general catalogue. Per maggiori informazioni riferirsi al catalogo generale Outdoor Design.
 (5) Only for products with 20 mm thickness. Solo per prodotti a 20mm di spessore.
 (●) PTV ≥ 36 Wet on demand / su richiesta (●●) P3 on demand / su richiesta (●●●) C2 on demand / su richiesta

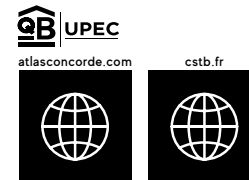

Beige & Brown

RANGE SUMMARY (1) (5)

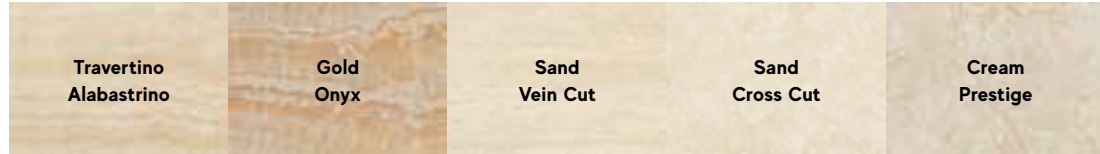

PORCELAIN TILES

160x320 cm 63"x126"	± 6 mm				
120x278 cm 47 1/4"x109 1/2"	± 6 mm		Matte		
120x240 cm 47 1/4"x94 1/2"	± 9 mm		Matte		
160x160 cm 63"x63"	± 6 mm				
120x120 cm 47 1/4"x47 1/4"	± 9 mm			Matte (S)	
60x120 cm 23 5/8"x47 1/4"	± 9 mm		Matte (S)	Matte (S)	
75x150 cm 29 1/2"x59"	± 9 mm	Polished	Polished		Polished
75x75 cm 29 1/2"x29 1/2"	± 9 mm	Polished	Polished		Polished
37,5x75 cm 14 3/4"x29 1/2"	± 9 mm				
60x60 cm 23 5/8"x23 5/8"	± 9 mm	Polished Matte (S)		Matte (S)	Polished Matte (S)
30x60 cm 11 3/4"x23 5/8"	± 9 mm	Polished Matte (S)			Polished Matte (S)

OUTDOOR AND WET AREAS

60x120 cm 23 5/8"x47 1/4"	± 9 mm		Grip	Grip	
60x120 cm 23 5/8"x47 1/4"	± 20 mm		Outdoor		

WALL TILES

50x120 cm 19 5/8"x47 1/4"	± 8,5 mm				Shiny
40x80 cm 15 3/4"x31 1/2"	± 8,5 mm	Shiny			Shiny
30,5x91,5 cm 12"x36"	± 8,5 mm	Shiny			
30,5x56 cm 12"x22"	± 8,5 mm				
8x31,5 cm 3 1/8"x12 1/2"	± 8,5 mm				

SLABS FOR FURNITURE

	± 6 mm				
162x324 cm 63 3/4"x127 1/2"	± 12 mm		Hammered		
> Non rectified	± 20 mm				



PORCELAIN TILES

Matte						Polished
Matte						
	Matte (S)				Polished	Polished
Matte (S)	Matte (S)					
					Polished	Polished
		Polished Matte (S)		Polished	Polished Matte (S)	Polished
	Matte (S)	Polished Matte (S)		Polished Matte (S)	Polished Matte (S)	Polished Matte (S)
		Polished Matte (S)		Polished Matte (S)	Polished Matte (S)	Polished Matte (S)

OUTDOOR AND WET AREAS

Grip	Grip					
Outdoor						

WALL TILES

				Shiny		
			Shiny	Shiny		Shiny
		Shiny			Shiny	
		Shiny			Shiny	

SLABS FOR FURNITURE

Hammered						

* Also available in bookmatch® For notes 0-2-4-9 see page 133



ENJOY THE VIDEO



EN | IT | FR | DE | RU

OVERVIEW



HBA HIRSCH BEDNER ASSOCIATES



IMAGE GALLERY



SURFACE RANGE & TECHNICAL SPECS.



MARVEL WORLD



WE CARE



Grey & Black

RANGE SUMMARY (1) (5)

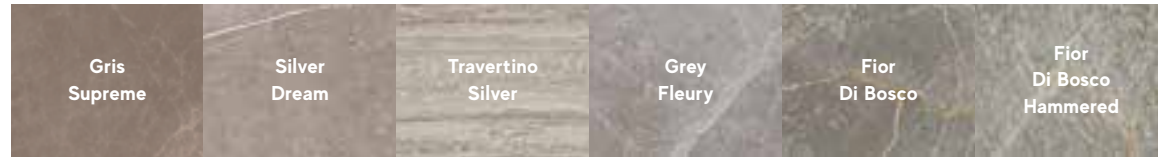

PORCELAIN TILES

160x320 cm 63"x126"	± 6 mm						
120x278 cm 47 1/4"x109 1/2"	± 6 mm			Polished Matte	Polished Silk		
120x240 cm 47 1/4"x94 1/2"	± 9 mm				Polished		
160x160 cm 63"x63"	± 6 mm						
120x120 cm 47 1/4"x47 1/4"	± 9 mm	Polished		Polished Matte (S)	Polished Silk		
60x120 cm 23 5/8"x47 1/4"	± 9 mm			Polished Matte (S)	Polished Matte (S)	Polished Matte (S)	
75x150 cm 29 1/2"x59"	± 9 mm	Polished	Polished	Polished *	Polished Silk		
75x75 cm 29 1/2"x29 1/2"	± 9 mm	Polished	Polished	Polished	Polished Silk		
37,5x75 cm 14 3/4"x29 1/2"	± 9 mm						
60x60 cm 23 5/8"x23 5/8"	± 9 mm	Polished Matte (S)	Polished Matte (S)	Polished Matte (S)	Polished Matte (S)		
30x60 cm 11 3/4"x23 5/8"	± 9 mm	Polished Matte (S)	Polished Matte (S)	Polished Matte (S) Textured	Polished Matte (S)		

OUTDOOR AND WET AREAS

60x120 cm 23 5/8"x47 1/4"	± 9 mm						
60x120 cm 23 5/8"x47 1/4"	± 20 mm						Outdoor

WALL TILES

50x120 cm 19 5/8"x47 1/4"	± 8,5 mm						
40x80 cm 15 3/4"x31 1/2"	± 8,5 mm		Shiny	Shiny	Shiny		
30,5x91,5 cm 12"x36"	± 8,5 mm		Shiny	Shiny	Shiny		
30,5x56 cm 12"x22"	± 8,5 mm		Shiny				
8x31,5 cm 3 1/8"x12 1/2"	± 8,5 mm						

SLABS FOR FURNITURE

162x324 cm 63 3/4"x127 1/2" > Non rectified	± 6 mm						
	± 12 mm						
	± 20 mm						



PORCELAIN TILES

Polished Silk			Polished Matte	Polished	Polished		Polished Matte
Polished			Polished	Polished			Polished
Polished Silk			Polished Matte (S)	Polished	Polished		Polished Matte (S)
Polished Matte (S)			Polished Matte (S)		Polished		Polished Matte (S)
Polished Silk	Polished	Polished Matte (S)	Polished	Polished Matte (S)		Polished	Polished Matte (S)
Polished Silk	Polished	Polished Matte (S)	Polished Matte (S)	Polished Matte (S)		Polished	Polished Matte (S)
		Polished Matte (S)		Polished Matte (S)			Polished Matte (S)
Polished Matte (S)	Polished Matte (S)	Polished Matte (S)	Polished Matte (S)	Polished Matte (S)		Polished Matte (S)	Polished Matte (S)
Polished Matte (S)	Polished Matte (S)		Polished Matte (S)			Polished Matte (S)	Polished Matte (S)

WALL TILES

	Shiny	Shiny		Shiny		Shiny	Shiny	Shiny
	Shiny					Shiny	Shiny	
						Shiny		

SLABS FOR FURNITURE

			Silk	Silk			Silk
			Silk	Polished Silk			Satin Polished Silk
			Silk				Silk

* Also available in bookmatch® For notes 0-2-4-9 see page 133



Precious

RANGE SUMMARY (1) (5)



PORCELAIN TILES

160x320 cm 63"x126"	± 6 mm				
120x278 cm 47 1/4"x109 1/2"	± 6 mm	Polished	Polished		
120x240 cm 47 1/4"x94 1/2"	± 9 mm				
160x160 cm 63"x63"	± 6 mm				
120x120 cm 47 1/4"x47 1/4"	± 9 mm	Polished	Polished		
60x120 cm 23 5/8"x47 1/4"	± 9 mm	Polished	Polished		
75x150 cm 29 1/2"x59"	± 9 mm			Polished	Polished *
75x75 cm 29 1/2"x29 1/2"	± 9 mm			Polished	
37,5x75 cm 14 3/4"x29 1/2"	± 9 mm				
60x60 cm 23 5/8"x23 5/8"	± 9 mm				
30x60 cm 11 3/4"x23 5/8"	± 9 mm				

WALL TILES

50x120 cm 19 5/8"x47 1/4"	± 8.5 mm				Shiny
40x80 cm 15 3/4"x31 1/2"	± 8.5 mm				
30,5x91,5 cm 12"x36"	± 8.5 mm				
30,5x56 cm 12"x22"	± 8.5 mm				
8x31,5 cm 3 1/8"x12 1/2"	± 8.5 mm				

SLABS FOR FURNITURE

	± 6 mm				
162x324 cm 63 3/4"x127 1/2" > Non rectified	± 12 mm	Polished * Silk *	Polished * Silk *		
	± 20 mm	Polished	Polished		

* Also available in bookmatch® For notes 0-2-4-9 see page 133

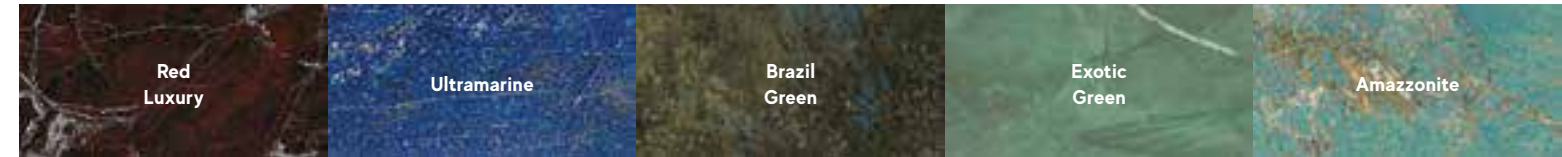

PORCELAIN TILES

	Polished		Polished	Polished
			Polished	Polished
			Polished	Polished
Polished	Polished	Polished		
Polished	Polished	Polished		

WALL TILES

	Shiny	Shiny		

SLABS FOR FURNITURE

			Polished * Silk *	Polished * Silk *

Marvel Calacatta Extra, Moon Onyx, Champagne Onyx, Beige Mystery, Bronze Luxury, Silver Dream, Grey Stone

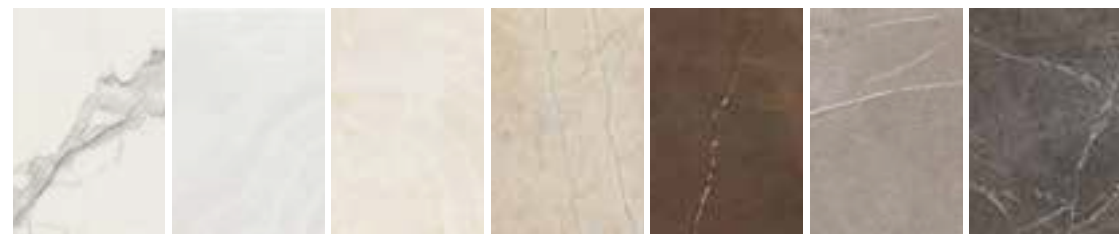

Marvel Pro Statuario Select, Crema Delicato, Travertino Alabastrino, Travertino Silver, Grey Fleury, Noir St. Laurent



Marvel Stone Carrara Pure, Bianco Dolomite, Cream Prestige, Bardiglio Grey, Nero Marquina



Marvel Edge Royal Calacatta, Imperial White, Elegant Sable, Gris Clair, Gris Supreme, Absolute Brown, Gold Onyx, Agata Azul, Red Luxury

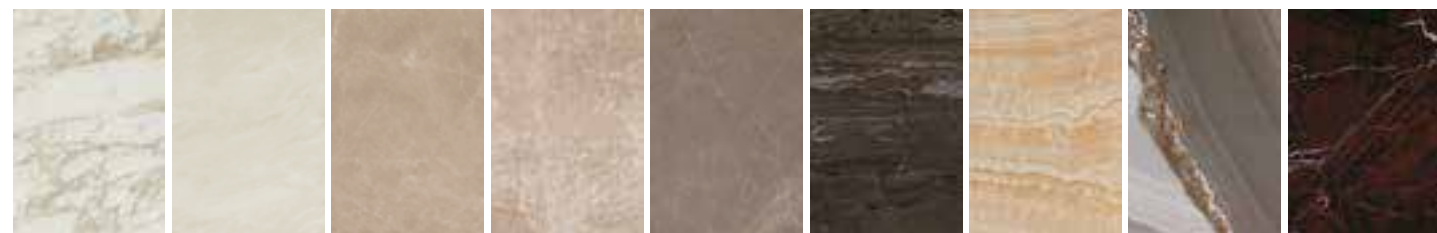

Marvel Dream Bianco Fantastico, Morning Sky, Grigio Intenso, Black Atlantis, Ultramarine, Brazil Green, Crystal Beauty

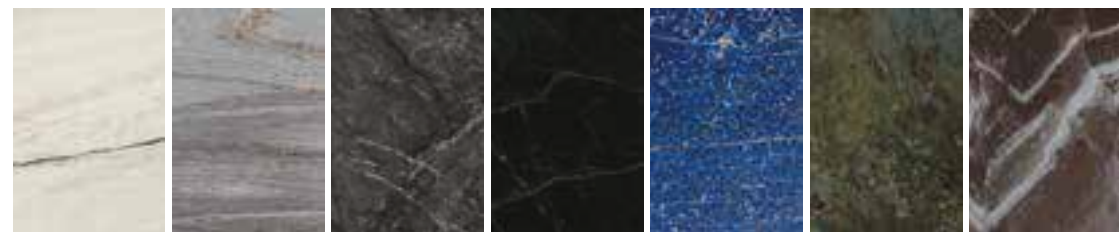

Marvel Shine Calacatta Delicato, Calacatta Prestigio, Statuario Supremo, Calacatta Imperiale



Marvel X Calacatta Apuano, Calacatta Sublime, Calacatta Perla, Grey Cloud, Fior di Bosco, Calacatta Apuano Hammered, Fior di Bosco Hammered

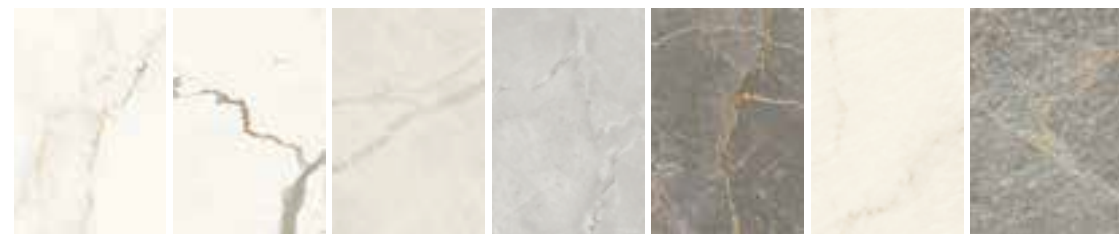

Marvel Travertine White Vein Cut, White Cross Cut, Sand Vein Cut, Sand Cross Cut, Pearl Vein Cut, Pearl Cross Cut



Marvel Gala Crystal White, Desert Soul, Amazonite, Exotic Green, Calacatta Black

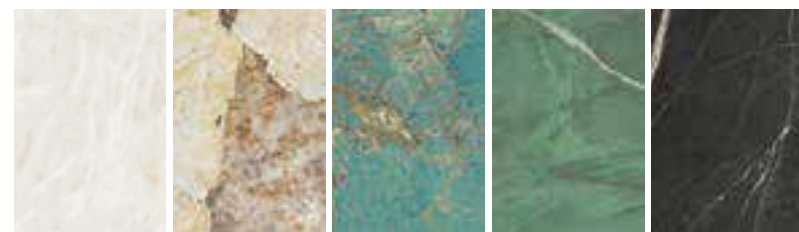

To learn more about the complete range of the collections, please refer to the catalogue of the series. - Per conoscere la gamma completa delle collezioni si invita a consultare il catalogo di serie. - Consulter le catalogue des séries pour découvrir la gamme complète des collections. - Die gesamte Produktpalette der Kollektionen finden Sie im Katalog der jeweiligen Serie. - Para conocer la gama completa de las colecciones, rogamos consultar el catalogo de serie. - Полная гамма коллекций представлена в соответствующих каталогах серий.

- The various graphics of the product are distributed randomly in the boxes, without the possibility of choosing between the available patterns.** - All'interno delle casse, le varie grafiche del prodotto sono distribuite in modo casuale, senza possibilità di scelta tra i pattern disponibili. - A l'intérieur delle caisses, les différents graphismes du produit sont distribués en mode aléatoire, sans possibilité de choix entre les motifs disponibles. - Die Kisten enthalten die verschiedenen Grafiken des Artikels nach dem Zufallsprinzip, ohne dass Sie zwischen den einzelnen Motiven wählen können. - En el interior de las cajas, los distintos gráficos de los productos se distribuyen de forma aleatoria, sin que se pueda elegir el patrón disponible. - Рисунки распределены в ящиках в случайном порядке, без возможности выбора из доступных рисунков.
- Calacatta Extra Endless is composed of four graphics with vein continuity, but are distributed randomly in the boxes, without the possibility of choosing between the available patterns.** - Calacatta Extra Endless è composto da quattro grafiche con continuità di vena, ma all'interno delle casse queste sono distribuite in modo casuale, senza possibilità di scelta tra i pattern disponibili. - Calacatta Extra Endless est composé de quatre graphismes avec les veines en continuité, mais celles-ci sont distribuées en mode aléatoire à l'intérieur delle caisses, sans possibilité de choix entre les motifs disponibles. - Calacatta Extra Endless besteht aus vier Grafiken mit durchlaufender Aderung, diese sind jedoch in den Kisten nach dem Zufallsprinzip enthalten, ohne dass Sie zwischen den einzelnen Motiven wählen können. - Calacatta Extra Endless se compone de cuatro gráficos con continuidad de vetas, pero en el interior de las cajas están distribuidos de forma aleatoria, sin que se pueda elegir el patrón disponible. - Calacatta Extra Endless состоит из четырех рисунков с непрерывными прожилками, но они распределены в ящиках в случайном порядке, без возможности выбора из доступных рисунков.
- Minor misalignments in the continuity of the veins between different graphics is normal for this type of product.** - Eventuali piccoli disallineamenti nella continuità delle venature tra grafiche diverse sono una caratteristica intrinseca di questa tipologia di prodotto. - Les éventuels petits désalignements de la continuité des veines entre différents graphismes sont une caractéristique intrinsèque de cette typologie de produit. - Eventuelle kleine Versätze im Verlauf der Aderungen zwischen unterschiedlichen Grafiken sind charakteristisch für dieses Produkt. - Cualquier pequeño desalineado en la continuidad de las vetas entre diferentes gráficos es una característica intrínseca de este tipo de productos. - Возможные небольшие смещения рисунка прожилок на стыке плит являются характеристикой данного вида изделий.
- The Endless Kit contains all the graphics of the product with vein continuity, ensuring that all the numbered faces in the composition can be found in a single box. The number of the graphic - G1, G2, G3, etc - is printed on the side and indicated with an adhesive label placed on the slab. To reconstruct the surface with continuous veins, simply lay the tiles in numerical progression: G1, G2, G3 and so on.** - Il Kit Endless contiene tutte le grafiche del prodotto con continuità di vena, garantisce in un'unica cassa tutte le facce numerate che creano la composizione. Il numero della grafica, indicato come G1, G2, G3, ecc. viene stampato sulla costa del lato 278 e indicato con un adesivo posto sulla lastra. Per ricostruire la superficie con continuità di vena è sufficiente posare le lastre in progressione numerica: G1, G2, G3, ecc. - Le Kit Endless contient tous les graphismes du produit avec la continuité des veines; il garantit, dans une seule caisse, toutes les faces numérotées qui créent la composition. Le numéro du graphisme, indiqué comme G1, G2, G3, etc. est imprimé sur le bord du côté 278 et indiqué avec un adhésif apposé sur la dalle. Pour reconstruire la surface avec les veines en continuité, il suffit de poser les dalles en progression numérique: G1, G2, G3, etc. - Kit Endless umfasst alle Grafiken des Produkts mit durchlaufender Aderung und damit alle nummerierten Oberflächen, aus denen sich die Komposition zusammensetzt, garantiert in einer einzigen Kiste. Die Nummer der Grafik, d.h. G1, G2, G3 etc., ist auf der Kante der 278 cm langen Seite aufgedruckt und auch mit einem Klebeetikett auf der Platte angegeben. Um das Gesamtbild mit durchlaufender Aderung zusammenzusetzen, werden die Platten einfach in numerischer Reihenfolge verlegt: G1, G2, G3 usw. - El Kit Endless contiene todas las caras del producto con continuidad de vetas, garantiza contar en una sola caja con todas las caras numeradas que forman la composición. El número del gráfico, indicado como G1, G2, G3, etc., está impreso en el borde del lado 278 y se indica mediante un adhesivo en la losa. Para reconstruir la superficie con continuidad de vetas, basta con colocar las losas en progresión numérica: G1, G2, G3, etc. - Kit Endless - это комплект, который содержит все плиты, необходимые для составления композиции с непрерывным рисунком прожилок. Все плиты пронумерованы и находятся в одном ящике. Номер плиты, обозначенный как G1, G2, G3 и т.д., напечатан на торце грани 278 и указан также на наклейке в углу плиты. Чтобы при облицовке создать рисунок с непрерывающимися прожилками, необходимо просто уложить плиты в последовательности: G1, G2, G3 и т.д.
- A polished finish is recommended for low-stress residential or commercial floors where anti-slip performance is not required. The surface's shine and superior ease of cleaning are the result of in-depth studies and extensive technical research aimed at ensuring its durability over time. If the product is in direct contact with the outside, use moisture and dirt absorption devices to prevent scratches. Small irregularities on the surface are an intrinsic feature of the product, intended to imitate the surfaces of natural stone.** La finitura lappata è indicata per pavimenti residenziali o commerciali poco sollecitati, laddove non siano richieste prestazioni antiscivolo. La lucentezza e l'elevata facilità di pulizia della superficie sono frutto di studi approfonditi e accurate ricerche tecniche volte a garantirne la persistenza nel tempo. Se il prodotto è a diretto contatto con l'esterno, prevedere dei dispositivi di assorbimento dell'umidità e dello sporco per prevenire la formazione di graffi. Piccole irregolarità superficiali sono una caratteristica intrinseca del prodotto, volte ad imitare le superfici delle pietre naturali. - La finition semi-polie est indiquée pour les sols résidentiels ou commerciaux à faibles contraintes, où la caractéristique antidérapante n'est pas nécessaire. La brillance et la grande facilité de nettoyage de la surface sont le résultat d'études approfondies et de recherches techniques précises visant à assurer sa pérennité dans le temps. Si le produit est en contact direct avec l'extérieur, prévoir des dispositifs d'absorption de l'humidité et des poussières pour prévenir la formation de rayures. Les petites irrégularités superficielles sont une caractéristique intrinsèque du produit et visent à imiter la surface de la pierre naturelle. - Die Oberflächenversion Gelappt eignet sich für Bodenbeläge in Wohnbereichen bzw. in gering beanspruchten Gewerberäumen, wenn keine Rutschfestigkeit erforderlich ist. Der Glanz und die einfache Reinigung der Oberfläche sind das Resultat eingehender technischer Studien, mit denen die langfristige Beständigkeit sichergestellt wurde. Kommt das Produkt direkt mit der externen Umgebung in Kontakt, so sind Feuchtigkeit und Schmutz mit geeigneten Mitteln aufzunehmen, um Kratzer zu vermeiden. Kleine Unregelmäßigkeiten der Oberflächen sind typisch für das Produkt, das die Oberflächen von Natursteinen nachempfunden. - El acabado lapado es adecuado para pavimentos residenciales o comerciales con poco tráfico, donde no se requiere un efecto antideslizante. El brillo y la gran facilidad de limpieza de la superficie son el resultado de profundos estudios e investigaciones técnicas precisas para asegurar su persistencia en el tiempo. Si el producto está en contacto directo con el exterior, proporcionar dispositivos de absorción de humedad y suciedad para evitar arañazos. Pequeñas irregularidades superficiales son una característica intrínseca del producto, diseñadas para imitar las superficies de las piedras naturales. - Лаппированная поверхность рекомендована для полов жилых и коммерческих помещений с невысокой интенсивностью эксплуатации, в которых от покрытия не требуется характеристик сопротивления скольжению. Блеск и легкая очищаемость являются результатом глубоких исследований, направленных на создание долговечного материала. Если плитка находится в непосредственном контакте с наружной средой, необходимо предусмотреть устройства поглощения влаги и грязи во избежание образования царапин. Небольшие неровности поверхности являются характеристикой данного изделия и призваны имитировать поверхность природного камня.



ENJOY THE VIDEO



EN | IT | FR | DE | RU

OVERVIEW



HBA HIRSCH BEDNER ASSOCIATES



IMAGE GALLERY



SURFACE RANGE & TECHNICAL SPECS.



MARVEL WORLD



WE CARE







© Ceramiche Atlas Concorde

We care

- 136 PORCELAIN TILES: A SAFE CHOICE
- 138 ENVIRONMENTAL SUSTAINABILITY
- 140 ETHICAL IDENTITY

INDEX 

ENJOY THE VIDEO 

EN | IT | FR | DE | RU

OVERVIEW 



HBA
HIRSCH
BEDNER
ASSOCIATES 

IMAGE
GALLERY 

SURFACE
RANGE &
TECHNICAL
SPECS. 

MARVEL WORLD 

WE CARE 

PORCELAIN TILES: A SAFE CHOICE
ENVIRONMENTAL SUSTAINABILITY
ETHICAL IDENTITY

Porcelain tiles: a safe choice.

DISCOVER MORE
EN | IT | FR | DE | ES | RU

HYGIENIC
Igienico

RECYCLABLE
Riciclabile

VERSATILE
Versatile

SAFE
Sicuro

FIREPROOF
Non brucia

EASY TO CLEAN AND DISINFECT
Facile da pulire e sanificare

ECO-FRIENDLY
Ama l'ambiente

LONG LASTING
Dura a lungo

RESISTANT
Resistente

ZERO PVC
Zero PVC



page 116

© Ceramiche Atlas Concorde

INDEX



ENJOY THE VIDEO



EN | IT | FR | DE | RU

OVERVIEW



HBA HIRSCH BEDNER ASSOCIATES



IMAGE GALLERY



SURFACE RANGE & TECHNICAL SPECS.



MARVEL WORLD



WE CARE



PORCELAIN TILES: A SAFE CHOICE
ENVIRONMENTAL SUSTAINABILITY
ETHICAL IDENTITY

Environmental sustainability.



CERTIFICATIONS

Company / Azienda



Product / Prodotto



Product "Declarations" / Dichiarazioni di prodotto



An ecological transition is among the company's industrial priorities. Our plants comply with the most stringent international regulations – fully automated and low-impact – as they are equipped with energy cogeneration systems. A constant commitment to the total reduction of waste and emissions completes the picture of a company oriented towards maximum environmental sustainability.

La transizione ecologica è tra le priorità industriali dell'azienda. I nostri impianti sono conformi alle più stringenti normative internazionali, completamente automatizzati e a basso impatto, in quanto dotati di sistemi di cogenerazione energetica. Il costante impegno per la totale riduzione degli sprechi e delle emissioni completano il quadro di un'azienda orientata alla massima sostenibilità ambientale.

La transition écologique est une des priorités industrielles de l'entreprise. Nos installations sont conformes aux réglementations internationales les plus sévères, entièrement automatisées et à faible impact, car équipées de systèmes de cogénération énergétique. L'engagement constant pour la réduction totale du gaspillage et des émissions complète le tableau d'une entreprise engagée pour une meilleure durabilité environnementale.

Der ökologische Wandel gehört zu den Prioritäten der industriellen Strategie des Unternehmens. Unsere Anlagen entsprechen den strengsten internationalen Richtlinien; sie arbeiten vollautomatisch und umweltschonend, denn sie sind mit Kraft-Wärme-Kopplungssystemen ausgerüstet. Ein weiterer Aspekt dieses Unternehmens, das sich ganz der Erreichung maximaler ökologischer Nachhaltigkeit verschrieben hat, ist sein kontinuierliches Engagement für die völlige Eliminierung von Verschwendung und Emissionen.

La transición ecológica está entre las prioridades industriales de la empresa. Nuestras plantas cumplen las normas internacionales más estrictas, totalmente automatizadas y de bajo impacto, ya que están equipadas con sistemas de cogeneración energética. Los esfuerzos constantes por reducir completamente los residuos y las emisiones completan la imagen de una empresa centrada en la máxima sostenibilidad medioambiental.

Экологический переход – один из основных технологических приоритетов компании. Наши производственные процессы отвечают требованиям строжайших международных стандартов, автоматизированы, оказывают минимальное воздействие на окружающую среду, а кроме того, на заводе работает собственная когенерационная установка. А еще мы принимаем меры по сокращению отходов и выбросов, что является еще одним свидетельством ориентации на экологическую устойчивость.



© Ceramiche Atlas Concorde

INDEX



ENJOY THE VIDEO



EN | IT | FR | DE | RU

OVERVIEW



HBA HIRSCH BEDNER ASSOCIATES



IMAGE GALLERY



SURFACE RANGE & TECHNICAL SPECS.



MARVEL WORLD



WE CARE



PORCELAIN TILES: A SAFE CHOICE
ENVIRONMENTAL SUSTAINABILITY
ETHICAL IDENTITY

Ethical identity.



For Atlas Concorde, being Made in Italy is not just a prestigious certification of style, design, and production excellence, but an identity that involves all aspects of its business. For this reason, we identify with the values expressed by Confindustria Ceramica's ethical code, which guarantee absolute compliance with labor regulations, and with the marks Made in Italy and Ceramics of Italy, which certify the quality of authentic Italian style.

Per Atlas Concorde, Made in Italy non è solo un prestigioso attestato di stile, design ed eccellenza produttiva, ma un modo di essere che coinvolge tutti gli aspetti della propria attività. Per questo ci riconosciamo nei valori espressi dal codice etico di Confindustria Ceramica, che garantiscono il rispetto assoluto delle normative sul lavoro, e nei marchi Made in Italy e Ceramics of Italy, che certificano la qualità dell'autentico stile italiano.

Pour Atlas Concorde, le Made in Italy n'est pas seulement une prestigieuse attestation de style, de design et d'excellence de la production, mais une manière d'être qui prend en compte tous les aspects de notre activité. C'est pourquoi nous nous reconnaissons d'abord dans les valeurs exprimées dans le code éthique de Confindustria Ceramica qui garantissent le respect absolu des réglementations sur le travail, mais aussi dans les labels Made in Italy et Ceramics of Italy qui certifient la qualité du vrai style italien.

Für Atlas Concorde ist das Made in Italy mehr als nur ein prestigevolles Gütezeichen für Stil, Design und exzellente Produktion. Es ist eine Einstellung, die alle Aspekte der Tätigkeit einbezieht. Wir teilen die im Ethikcode des Unternehmerverbands Confindustria Ceramica zum Ausdruck kommenden Werte, welche die strenge Einhaltung der arbeitsrechtlichen Vorschriften garantieren, sowie jene der Gütesiegel Made in Italy und Ceramics of Italy als Garantie von Qualität in authentischem, italienischem Stil.

Para Atlas Concorde, Made in Italy no es sólo un prestigioso certificado de excelencia en estilo, diseño y fabricación, sino una forma de ser que abarca todos los aspectos de su actividad. Por eso nos identificamos con los valores expresados en el código ético de Confindustria Ceramica, que garantizan el respeto absoluto de la normativa laboral, y de las marcas Made in Italy y Ceramics of Italy, que certifican la calidad del auténtico estilo italiano.

«Made in Italy» для Atlas Concorde не просто знак подтверждения стиля и качественного производства, а образ жизни, который включает в себя все аспекты деятельности. Поэтому мы полностью разделяем ценности, закрепленные в «Этическом кодексе» федерации Confindustria Ceramica (ассоциация предприятий керамической отрасли) и предусматривающие строгое соблюдение трудового законодательства. А маркировка Made in Italy и Ceramics of Italy на нашей плитке является гарантией ее качества и аутентичного итальянского дизайна.



© Ceramiche Atlas Concorde

INDEX



ENJOY THE VIDEO



EN | IT | FR | DE | RU

OVERVIEW



HBA HIRSCH BEDNER ASSOCIATES



IMAGE GALLERY



SURFACE RANGE & TECHNICAL SPECS.



MARVEL WORLD



WE CARE



PORCELAIN TILES: A SAFE CHOICE
ENVIRONMENTAL SUSTAINABILITY
ETHICAL IDENTITY



Ceramiche Atlas Concorde S.p.A.
Via Canaletto 141
41042 Spezzano di Fiorano (MO) - Italia

Atlas Concorde USA, Inc.
117 Seaboard Lane - Suite F170
Franklin, TN 37067 - USA

Atlas Concorde Russia
Business centre "Meliora Place"
Prospekt Mira 6
129090 Moscow - Russia

atlasconcorde.com

Copyright 2022 by Ceramiche Atlas Concorde S.p.A.
(Spezzano di Fiorano, MO - Italy)
September 2022